

Betjeningsvejledning for aftrækstumbler til ejendomme og industri



SCHULTHESS

Spirit TopLine

TA 6257

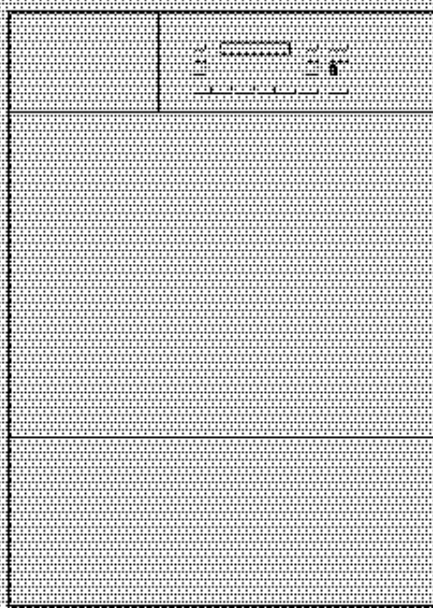

WT 07



Produkt-nr.

6257.0

Instruktions-nr.

635 904.AA

EG-KONFORMITÄTSERKLÄRUNG FÜR MASCHINEN

(EC Directive 98/37/EEC, Attachment II, sub. A)

Hersteller: Schulthess Maschinen AG
Adresse: Landstrasse 37, CH-8633 Wolfhausen, Schweiz

erklärt hiermit, dass die Wäschetrockner der nachstehenden Typen:

Typ:	Spirit TopLine TA 6257	Spirit TopLine TC 6457
Prod.-Nr.	6257.0	6457.0
Prod.-Nr.	6257.1	6457.1

- konform sind mit den einschlägigen Bestimmungen der EG-Maschinenrichtlinie (EC Directive 98/37/EEC, Attachment II, sub. A), inklusive deren Änderungen, sowie mit dem entsprechenden Rechtserlass zur Umsetzung der Richtlinie ins nationale Recht.
- konform sind mit den einschlägigen Bestimmungen folgender weiterer EG-Richtlinien:
2004/109/EG Electromagnetic compatibility
2006/95/EG Low-voltage directive.

Des weiteren erklären wir, dass

- folgende harmonisierten Normen (oder Teile/Klauseln hieraus) zur Anwendung gelangten:

**IEC 60335-2-11:02; EN 60335-1:02; EN 60335-2-11:03; IEC 61000-3-2:01; IEC 61000-3-3:94
EN 61000-3-2:00; EN 61000-3-3:95; IEC 60335-1:01; IEC 60335-2-30:2; EN 60335-2-30:03
EN 55014-2:97; CISPR 14-2:01; EN 50366:03; EN 55014-1:00; CISPR 14-1:00**

Wolfhausen, März 2008

SCHULTHESS MASCHINEN AG



Ch. Daneffel
Leitung Forschung und Entwicklung



H.-P. Caderas
Product Manager



Kære kunde

Tillykke med Deres valg af en SANIVA/Schulthess tørretumbler.

Deres nye tørretumbler er et resultat af mange års udviklingsarbejde. De højeste kvalitetsstandarder både med hensyn til udvikling og fremstilling garanterer en lang levetid.

Tumblerens koncept opfylder alle nuværende og fremtidige krav til moderne behandling af vasketøj. Samtidig får De med denne tumbler et stort og individuelt programvalg.

Gennemlæs venligst brugsvejledningen omhyggeligt for fuldt ud at kunne udnytte alle muligheder og fordele af Deres nye tørretumbler.

Bemærk ligeledes sikkerhedsanvisningerne på side 6.

Vi håber, at De bliver tilfreds med Deres nye SANIVA/Schulthess-tumbler.

Med venlig hilsen
SANIVA Vaskerimaskiner A/S

Indholdsfortegnelse

Bemærk		▷ LCD-lysstyrke/kontrast	14
▶ Bortskaffelsesråd	6	▷ Alarmtone-lydstyrke	15
▷ Den nye maskines emballage	6	▷ Standby-funktion	15
▷ Gamle maskiner	6	▷ Optisk interface	15
▶ Sikkerhedsanvisninger og advarsler	6	▷ Fejlsprog	15
▶ Miljøbeskyttelse og spareråd	6		
Deres nye tørretumbler		Kontantkort	
▶ Beskrivelse af maskinen	7	▶ Indsættelse af kontantkort	15
▶ Vaskeanvisninger	8	▶ Udtagning af kontantkort	15
▷ Sortering af vasketøj	8	▶ Valg af tørreprogram	15
▷ Tips til tørring	8	▶ Tekst i display under programforløb	15
Ibrugtagning		▶ Program slut	15
▶ Forberedelse	8	▶ Genbestilling	15
▶ Åbning af dør	8	▶ Overførsel af restbeløb	15
▶ Ifyldning af vasketøj	8		
▶ Lukning af dør	8	Fejl	
Tørring		▶ Små fejl, De selv kan udbedre	16
▶ Programoversigt	9/10	▶ Fejlmeddelelser	16/17
▶ Tørring	11		
▷ Tørreprogrammer	11	Kundeservice	
▷ Ekspresprogram	11	▶ Produkt- og maskin-nr.	17
▷ Mix-program	11		
▷ Tidsprogrammer	11		
▷ Specialprogrammer	11		
▷ Valg af ekstraprogrammer	11		
▷ Start program	11		
▷ Programforløb/programmstatus	11		
▷ Ændring af program	12		
▷ Afbrydelse af program	12		
▷ Ifyldning af ekstra tøj	12		
▷ Program slut	12		
▷ Udtagning af vasketøj	12		
▷ Slukning af maskine	12		
▶ Ekstra funktioner	12		
▷ Strygefrit	12		
▷ Programmering af starttid	12		
▷ Skånetørring	12		
▷ Skånetørring ekstra	12		
▷ Ilgang	12		
Vedligeholdelse/pleje/rensning			
▶ Rensning af maskinen	13		
▷ Rensning af filter	13		
▷ Rensning af fugtfølere	13		
Grundindstillinger			
▶ Tørringsgrad	14		
▶ Anti-krøl	14		
▶ Indstilling af tid	14		
▶ Sprog	14		
▶ Yderligere grundindstillinger	14		
▷ Børnesikring	14		
▷ Lagring af taster	14		
▷ Nedsat strømforsyning	14		

Bortskaffelsesråd

Emballage fra den nye maskine

⚠ Sørg for korrekt bortskaffelse af emballagen.

⚠ Emballage er ikke legetøj.

Via behandling og genanvendelse spares råmaterialer samt affaldsmængden reduceres.

Emballagen kan returneres til forhandler eller leverandør.

Alle anvendte emballagematerialer er nedbrydelige i miljøet og kan genbruges. Kartonen består af 80% til 100% genbrugspapir.

Træmaterialer er ikke behandlet med kemikalier. Plastikovertrækket er lavet af polyethylen (PE), sikkerhedstapen af polypropylen (PP). Disse materialer er rene kulbrinteforbindelser og kan genanvendes.

Gamle maskiner

⚠ Udtjente maskiner skal gøre ubrugelige:

Efter at stikket er trukket ud eller den elektriske forbindelse er afbrudt af en elektriker, gennemskares el-kabler eller fjernes helt. Dørlåsen ødelægges eller fjernes, således at legende børn ikke kan lukke sig selv inde og udsættes for fare.

Symbolet  på produktet eller emballage angiver, at dette produkt skal indleveres på et opsamlingssted til genbrug af elektroniske apparater.

Ved at sørge for korrekt bortskaffelse af dette produkt beskytter De miljøet og Deres medmenneskers sundhed. Miljø og sundhed bringes i fare ved ukorrekt bortskaffelse.

Den gamle maskine indeholder værdifulde materialer, som kan genbruges. Adresser på opsamlingssteder eller genbrugsstationer fås hos de lokale kommunale myndigheder eller dér, hvor De har købt maskinen.



Hvad gør vi med den gamle maskine?

Overalt hvor der sælges nye maskiner eller på kommunale opsamlingssteder.

Spørg Deres leverandør eller Deres kommune.

Sikkerhedsråd og advarsler

Denne maskine opfylder de gældende sikkerhedsregler for elektriske apparater.

Bemærk venligst før ibrugtagning.

⚠ Gennemlæs omhyggeligt det vedlagte trykte materiale, før De tager Deres tørretumbler i brug. Her vil De finde vigtige informationer vedrørende maskinens installation, brug og sikkerhed.

⚠ Reparationer må kun udføres af fagfolk. Ukorrekte reparationer kan forårsage betydelig materiel skade samt udgøre en fare for brugeren.

⚠ Det trykte materiale bør opbevares på et sikkert sted til brug for andre brugere og kommende ejere.

⚠ Maskinen installeres i henhold til installationsinstruktionerne.

⚠ En maskine med synlig skade må ikke installeres. I tvivlstilfælde kontaktes kundeservice eller leverandør.

Bemærk venligst ved tørring:

⚠ Børn bør ikke være i nærheden af maskinen uden opsyn.

⚠ Husdyr skal holdes væk fra maskinen.

⚠ Maskinen må kun benyttes til tørring af tekstiler.

Bemærk venligst efter tørring:

⚠ Undlad at række ind i den roterende tromle.

Beskyttelse af maskinen:

⚠ Undlad at kravle op på maskinen.

⚠ Undlad at sidde på, læne eller hvile Dem på lugen (maskinen kan tippe!).

Bemærk ved transport af maskinen:

⚠ Forsigtig ved transport af maskinen! (Risiko for at komme til skade!) Løft ikke maskinen i de fremskudte dele!

Miljøbeskyttelse og sparetips

Sådan sparer De strøm, tid og penge:

- ▶ Den billigste og mest miljøvenlige brug af tumbleren opnås ved at ifylde den maksimale tøjmenge.
- ▶ Den maksimale tøjmenge bør ikke overskrides (se programoversigt side 9/10).
- ▶ Tøjet centrifugeres grundigt enten i vaskemaskine eller centrifuge, før det tørres. Jo højere centrifugeringshastighed, jo kortere tørretid og jo lavere el-forbrug.
- ▶ Strygefrit tøj bør også centrifugeres.
- ▶ Sørg for, at rummet er godt ventileret under tørring (åbn et vindue eller en dør).
- ▶ Filter renses efter hver tørring.

Beskrivelse af maskinen

Betjeningspanel og display

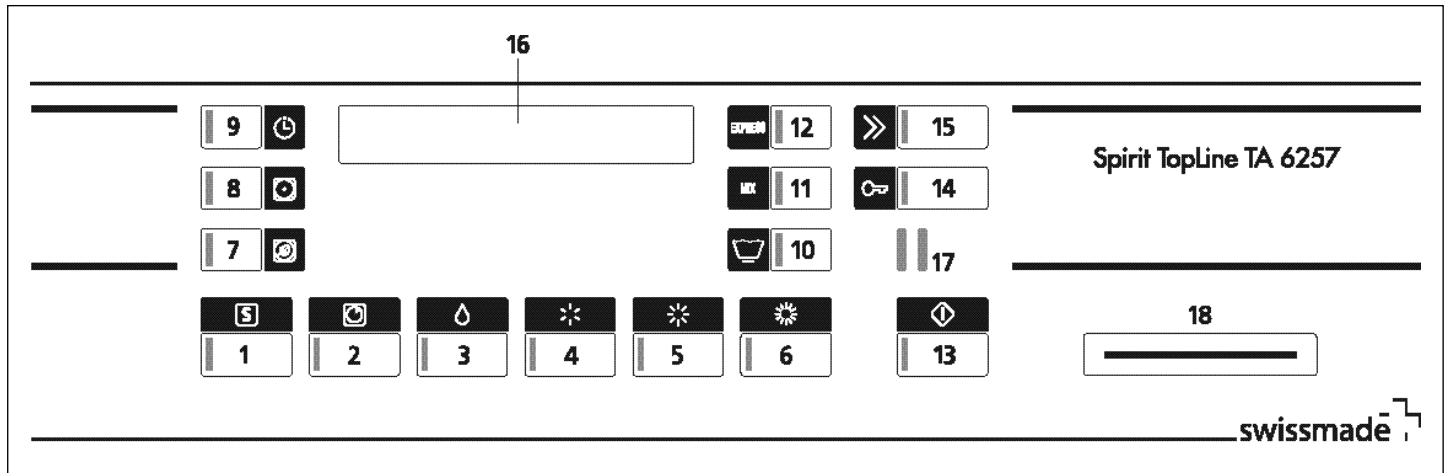

Programmer

- 1 Specialprogrammer
- 2 Tidstørring
- 3 Strygetørt
- 4 Let tørt
- 5 Skabstørt
- 6 Ekstra tørt
- 11 Blandet vasketøj
- 12 Ekspres

Meddelelser

- 16 Meddelelser i display

Interfaces

- 17 SCS-Schulthess Control System (PC-interface til kundeservice)
- 18 Sprække til kontantkort(option)

Ekstra funktioner

- 7 Skånetørring ekstra
- 8 Skånetørring
- 9 Forprogrammering af starttid
- 10 Strygefri
- 13 Programstart
- 14 Åbning af dør
- 15 Ilgang

Betjeningspanel og display

Filter

Ifyldningslåge

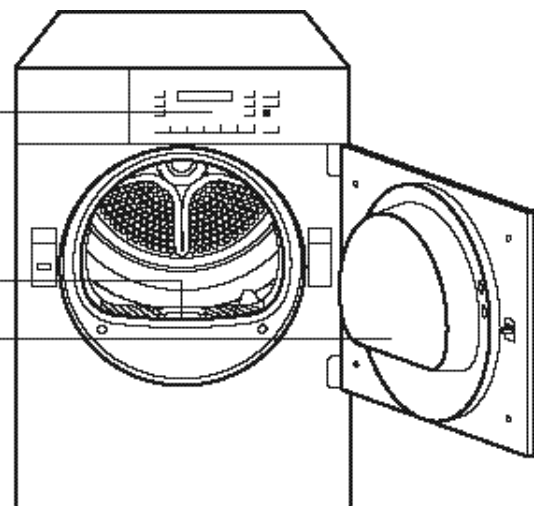



Vaskeanvisninger

Sortering af vasketøj

 Læg godt mærke til tørresymbolerne i tøjet.

 Tørring med normal temperatur.

 Tørring med lavere temperatur.



 Må ikke tørres i tørretumbler.

 Følgende tekstiler må ikke tørres i tumbleren:

- Sarte stoffer (silke, syntetiske gardiner etc.): Tøjet krøller!
- Dryptørt vasketøj: Spild af energi!
- Uld eller tekstiler med uld (undtagen med specialprogrammet «Uld finish»): Risiko for, at tøjet filtrer!

► For at opnå et ensartet tørreresultat, bør tøjet sorteres efter stoftype og det ønskede tørreresultat. Den maksimale ifyldningsmængde må ikke overskrides, da overfyldning resulterer i et dårligt tørreresultat samt at tøjet krøller.

Tips til tørring

- Luk lynlåse, hæfter og tryklåse. Dyne- og pudeberæk knappes. Løse bæltter etc. bindes sammen.
- Strygefrit tøj bør tages ud af maskinen i let fugtig tilstand (vælg tørreprogram «Lettørt») og lad det tørre færdigt i luften. Ved overtørring kan tøjet krølle.
- Tøj, som efter tørring af forskellig slags stof endnu er fugtigt, kan eftertørres i tidsprogrammet .
- Strikkede ting samt undertøj kan krympe noget. Brug aldrig programmet «Ekstratørt»  til disse tekstiler.

Ibrugtagning

 Maskinen installeres i henhold til installationsvejledningen. Før maskinen tages i brug, bør tromlen tørres med en fugtig klud.

Forberedelse

Følgende bør kontrolleres:

- Fugtfilter er isat. (Se Vedligeholdelse/Pleje/Rengøring side 13)
- Stikket er sat i eller vægkontakt tændt.

Maskinen er klar til brug, når alle kontrollamper lyser eller er gået over på standby. Hvis en kontrollampe lyser konstant, gøres følgende:

- Tryk på ilgangsknap til program slut, indtil kontrollampen lyser. Vent til kontrollampen blinker og tryk på tasten «Åbn» (udtag evt. tøj).

Åbning af dør



- Tryk på tasten «Åbn».
- Døren springer op.
- Bemærk: Døren springer kun op, hvis hovedkontakten er tændt. Skulle der ikke være nogen strøm, før døren åbnes, kan døren åbnes manuelt med et kort tryk på ydersiden af døren i højde med dørlåsen.
- Tromlebelysning tændes, når døren åbnes.

Ifyldning af vasketøj



Før tøjet lægges i tumbleren, bør De sikre Dem, at der ikke er nogen fremmedlegemer eller eventuelt indespærrede dyr i tromlen.



Læg kun tøj i tumbleren, der er vasket i vand.



Tøj, der er behandlet med antændelige opløsningsmidler, f.eks. med pletfjerner eller rensbenzin, må ikke tørres (eksplosionsfare!).



Tekstiler, der indeholder skumgummi, neglelakfjerner, hårspray eller lignende, må ikke tørres i tumbleren (brandfare!).

- Ilæg vasketøjet godt løsnet i tromlen, store og små stykker tøj blandet.

Lukning af dør

- Luk døren ved at presse den i, indtil De kan høre låsen klikke på plads.

- Sørg for, at intet tøj sætter sig fast mellem tumbler og dør, når døren lukkes.



Hvis døren ikke er lukket korrekt, forhindrer en sikkerhedskontakt, at maskinen kan starte.

















Programoversigt

A Beachten Sie stets die Pflegekennzeichen der Textilien

Pleje-symbol	Maks. tøj-mængde	Tekstiler/tøjtype	Programmer Tørhedsgrad	Knapper til programvalg	Centrifugeret i vaskemaskine ved omdr./min.	Strømforbrug ca. kWh	Ca. tid i min.
Køge- og kulørt tøj af bomuld eller linned							
	7,5 kg	<ul style="list-style-type: none"> ● Sengelinned, duge og håndklæder T-Shirts, Polo-bluser, arbejdstøj ● T-Shirts, polobluser, kjoler, benklæder, arbejdstøj, undertøj ● Frotté, viskestykker og håndklæder sengelinned, undertøj, bomuldssocker ● Frottébadekåber og -sengetøj Intet undertøj og ingen sokker 	<p>► Til tøj, der skal stryges med et strygejern</p> <p>► Til tøj, der ikke skal stryges eller som blot skal stryges let over</p> <p>► Til tøj, som ikke skal stryges</p> <p>► Til særligt tykt tøj eller tøj med flere lag</p>	 + + +	1400 1000 1400 1000 1400 1000 1400 1000	2,4 2,9 3,0 3,5 3,3 3,9 3,6 4,2	30 35 36 41 41 47 45 50
Strygefrit tøj af syntetiske eller blandingsstoffer samt strygefrit bomuld f.eks. viskose, polyester etc.							
	3,5 kg	<ul style="list-style-type: none"> ● Benklæder, kjoler, nederdele, skjorter ● Benklæder, kjoler, nederdele, skjorter, bluser korsetter, leggins, sportstøj med højt indhold af syntetiske stoffer ● Skjorter, bluser, sportstøj sengelinned, duge, træningstøj ● Anorakker, tæpper 	<p>► Til tøj, der skal stryges med strygejern</p> <p>► Til tøj, der ikke skal stryges eller kun skal stryges let over</p> <p>► Til tøj, der ikke skal stryges</p> <p>► Til særligt tykt tøj eller tøj med flere lag</p>	+ + + +	800 600 800 600 800 600 800 600	0,9 1,1 1,1 1,3 1,3 1,6 1,7 1,9	18 22 23 27 27 31 33
Specialprogrammer							
	2,3 kg	<ul style="list-style-type: none"> ● Sportstøj, Syntetisk tøj og blandingsstoffer 	► Sports- og fritidstøj Tøjet bliver skabstørt		600	1,4	33
	3,5 kg	<ul style="list-style-type: none"> ● Mix Blandet vasketøj 	► Bomuld og blandingsstoffer Tøjet bliver ekstra tørt		800 600	2,5 2,7	45 50
		<ul style="list-style-type: none"> ● Tidstørring Enkelte tøjstykker, tøj med lavt fugtighedsindhold 	► Til eftertørring af endnu lidt fugtigt tøj				
A		Ved temperaturfølsomme tekstiler tryk desuden på tasten «Skånetørring» eller «Skånetørring Ekstra» !		+			
		De anførte forbrugsværdier og programvarighed er retningsgivende værdier, som blev opnået under normale forhold. Svingninger op til 10% er mulige. Ved maskiner med nedsat strømløsførelse, forlænges programtiderne tilsvarende.					

Programoversigt

 Beachten Sie stets die Pflegekennzeichen der Textilien

Pleje-symbol	Maks. tøj-mængde	Tekstiler/tøjtype	Program Tørreresultat	Taster til programvalg	Centrifugeret i vaskemaskine ved omldr./min.	Strømforbrug ca. kWh	Tid ca. min.
Specialprogrammer							
	3,5 kg	● Uld, der tåler maskinvask	<p>► Tøjet bliver mere laddent, men ikke tørt. Udtag tøj direkte efter programslut og læg det fladt til tørring på et frottéhåndklæde.</p>	<p> 1x</p>	800	0,1	5
	3,5 kg	● Jeans	<p>► Jeans og bomuldsbenklæder tørres til «Strygetørt». Det hænges derefter op og tørrer færdigt i luften.</p>	<p> 2x</p>	400	1,7	28
	2,3 kg	● Skjorter/bluser	<p>► Skjorter og bluser tørres til «Strygetørt». Programmet mindsker fold-dannelser, skåner tøjet og letter strygingen.</p>	<p> 3x</p>	400	1,1	20
	2,3 kg	● Outdoor-Beklædning	<p>► Til tørring af outdoor-beklædning, dynejakker etc.</p>	<p> 4x</p>	600	1,8	62
	1 Stük	● Puder store eller små	<p>► Hovedpunder, dynejakker etc. tørres til «Ekstra tørt». Hovedpunder vendes efter behov efter ca. 120 min.</p>	<p> 5x</p>	600	5,6	150
	7,5 kg	● Frotté	<p>► Frottéhåndklæder, badehåndklæder etc. af bomuld.</p>	<p> 6x</p>	max. 1400	3,7	43
	7,5 kg	● Sengelinned	<p>► Lagener, stiklagener, dynebetræk, hovedpunder etc. af bomuld. Dyne- og pudebetræk bør knappes..</p>	<p> 7x</p>	max. 1400	3,7	48
		Ved temperaturfølsomme tekstiler tryk også på tasten «Skånetørt» eller «Skånetørt Ekstra» !		<p> + </p>			
		De anførte forbrugsværdier samt programvarighed er retningsgivende værdier, som blev opnået under normale forhold. Svingninger op til 10% er mulige. Ved maskiner med nedsat strømtilførsel, forlænges programtiderne tilsvarende.					

Tørring

Tørreprogrammer

Det elektroniske scanneprogram kontrollerer løbende tøjets aktuelle tørringsgrad og afslutter automatisk programmet, når den indstillede tørhedsgrad er opnået.

Vælg program til koge- og kulørt vask eller strygefri tekstiler ifølge programoversigten.



- ▶ Tryk på programknappen.
- Kontrollampen for det valgte program lyser.
- ▶ Til strygefri tekstiler vælges ekstrafunktionen «Strygefri» .

Ekspres-program: 2,3 kg



Tørreprogram til hurtig tørring af syntetisk tøj, f.eks. sportstøj af syntetisk stof eller blandingsstof. Tøjet bliver skabstørt.

- ▶ Tryk på programknappen.
- Kontrollampen lyser.

Mix-Program: 3,5 kg



Tørreprogram til hurtig tørring af syntetisk tøj, f.eks. sportstøj af syntetisk stof eller blandingsstof. Tøjet bliver skabstørt.

- ▶ Tryk på programknappen.
- Kontrollampen lyser.

Tidsprogrammer



Tidsprogrammer til tørring af enkelte stykker tøj eller til eftertørring af allerede fortørrede tekstiler med lavt fugtighedsindhold.

Den tid, der behøves til tørring, afhænger af tøjtype, tøj mængde og tøjets fugtighed.

- ▶ Tryk på programknappen.
- Kontrollampen tidsprogram lyser og minimum tørretiden på 10 min. vises.
- ▶ Vælg tørretid ved gentagne tryk på knappen op til 150 min.

Specialprogrammer



Med specialprogrammerne kan specielle tekstiler tørres særligt korrekt.

Tryk igen på tast , til det ønskede program vises i displayet (se programoversigt side 8).

Vælg ekstrafunktioner



Efter valg af program blinker kontrollamperne for ekstrafunktionerne.

- ▶ Tryk på de(n) ønskede funktionsknapp(er). (se ekstrafunktioner side 12).
- Kontrollampen(rne) for de(n) valgte funktion(er) lyser.

Start program



- ▶ Tryk på startknappen.
- Kontrollampen lyser og programmet starter automatisk.
- ⚠ Med aktiv børnesikring:
 - ▶ Hold startknappen nede og tryk på ilgangsknappen.

Programforløb / Programstatus



▶ Ved de fugtighedsstyrede programmer kontrolleres tøjets fugtighed konstant af et elektronisk scanneprogram.

▶ Den resterende programtid vises. Denne resttid genberegnes flere gange under tørringen. Programmets reelle sluttidspunkt varierer derfor med få minutter.

▶ Ved tidsprogrammer vises resttiden, indtil programmet er slut.

Ændring af program før programstart

- ▶ Tryk på den ønskede programknap.
- Alle kontrollamper for de ekstrafunktioner, der kan vælges, blinker igen og alle indstillinger er slettet.
- ▶ Vælg eventuelt ekstrafunktioner.
- ▶ Start program.

Afbrydelse af program

 ▶ Afbrydelse af program ved at trykke flere gange på ilgangsknappen, indtil der på display vises «Program slut».

-  Med aktiv børnesikring:
- ▶ Hold startknappen nede.
 - ▶ Tryk samtidigt på ilgangsknappen.

Ilægning af ekstra tøj

er til enhver tid mulig.

 ▶ Tryk på knappen til døråbning.

- Tromlen bliver stående.
- ▶ Læg vasketøjet i maskinen.
- ▶ Luk døren.
- ▶ Tryk på startknappen.

-  Med aktiv børnesikring:
- ▶ Hold start- og ilgangsknap nede samtidigt.
 - Tørreprocessen fortsætter.

Program slut

Program slut vises med meddelelsen 00:00h, display-meddelelsen «Program slut» samt en blinkende kontrollampe.

- Signal lyder (kun med tændt tonealarmfunktion).
- ▶ I grundindstillingen er anti-krøl-funktionen tilsluttet. Efter programmet er slut, kører tromlen rundt med korte mellemrum, således at tøjet ikke krøller (i 30 eller 60 minutter).

Tøjet bør udtages senest på dette tidspunkt.

Udtagning af vasketøj

 ▶ Tryk på knappen til døråbning.

- Lyset tændes i tromlen.
- ▶ Tøjet tages ud.
- ▶ Filter renses (side 13).
- ▶ Luk døren

Slukning af maskine

- ▶ Sluk for strømmen på vægkontakten.

Ekstra funktioner

Ud over de forskellige standard tørreprogrammer får De også muligheden for at sammensætte Deres eget tørreprogram.

Ved at vælge én eller flere ekstrafunktioner kan De indstille programmet til at passe til netop Deres tøj.

- ▶ De har derudover mulighed for at ændre tumblersens standardindstillinger, således at de opfylder netop Deres behov (se side 14).

Strygefrit



Til strygefri tekstiler af syntetisk eller blandet stof samt strygefrit bomuld.

Forprogrammering af starttid



Ved at trykke én eller flere gange på «Valg af starttid» kan start af program udskydes op til 23,5 timer.

Dette gør det bl.a. muligt at udnytte de lave nattakster. Både start og afslutning af et program kan tilpasses netop Deres individuelle behov.

I displayet vises starttid og det forventede sluttidspunkt. Når De har trykket på startknappen, starter nedtælling til den indstillede tid.

Når den ønskede starttid er nået, starter programmet automatisk. Den aktuelle programvarighed vises.

Ændring af indstillet starttid

- Den indstillede tid kan afbrydes ved at trykke på ilgangsknappen. Starttid kan derefter indtastes på ny.

Bemærk

- Ved strømafbrydelse forbliver den aktuelle tid lagret. Der tages ikke hensyn til varigheden af strømafbrydelsen.

Skånetørring



Tryk på knappen for skånetørring ved meget temperaturfølsomme tekstiler af kunststof, f.eks. acryl.

Temperaturen nedsættes og tørretiden forlænges.

Skånetørring ekstra



Ved særligt følsomme tekstiler kan der trykkes på «Skånetørring ekstra». Temperaturen reduceres yderligere.

Ilgang



Programmet kan afkortes eller afbrydes med ilgangsknappen.

(Se «Ændring/afbrydelse af program»).

Vedligeholdelse/Pleje/Rengøring

Rengøring af maskinen

- ⚠ Før rengørings- og vedligeholdelsesarbejder, bør De sikre Dem, at strømforsyningen er slået fra.
- ⚠ Maskinen må ikke oversprøjtes med vand.
- ⚠ Brug ikke opløsningsmidler! Disse midler kan skade maskindele, udvikle giftige dampe og udgøre en eksplosionsfare!

Kabinet samt betjeningsdele må kun rengøres med vand og sæbe eller med et almindeligt rengøringsmiddel uden slibemiddel og opløsningsmidler.

Rensning af filter

Tøj afgiver fibre ved brug (tøjnug), som frigøres under tørring og samler sig i filtret på indersiden af døren. Derfor skal fnugfiltret renses efter hver tørring.

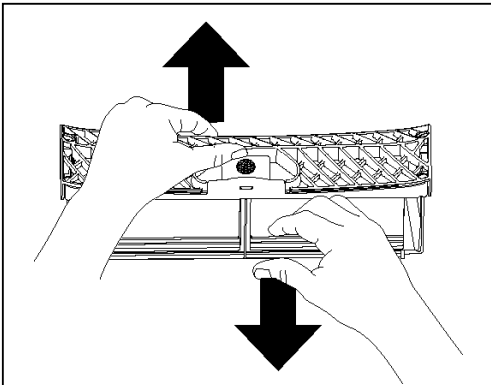
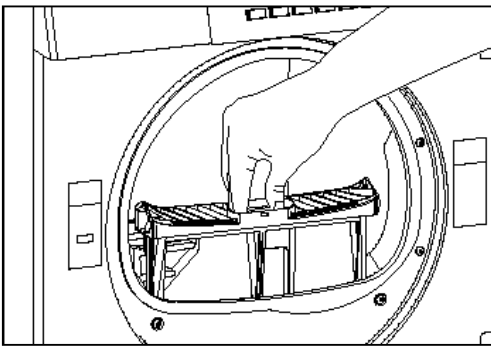

1. Tryk på dør-åbner-knappen.
2. Træk filter ud og klap op.
3. Stryg med hånden over filtret og fjern på denne måde fnugget. Det kan dog forekomme, at et ordentligt rensset filter kan være stoppet på grund af en fin, usynlig belægning i filtermaskerne.

Hold filtret med fladen op ad og hæld noget vand over det. Kan vandet ikke trænge igennem, rens da filtret med en børste under rindende vand.

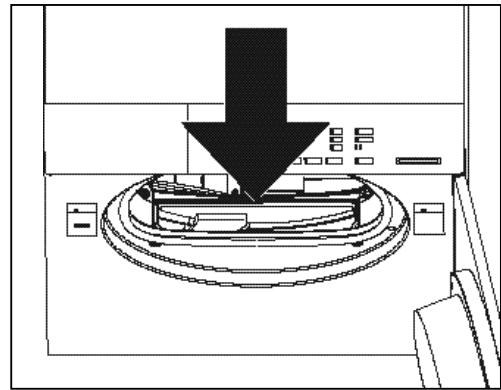

- 3.1 Fra tid til anden er det nødvendigt også at rense pakningen på indersiden af filterholderen og gerne de fnug, der har samlet sig inde i filterholderen. Dertil anvendes en støvsuger eller en rengøringspensel.
- 3.2 Støvsugerrør eller rengøringspensel føres ind i åbningen til fnugfiltret. De fnug, der ligger tilbage, fjernes grundigt.
4. Sæt filtret korrekt på plads igen.
5. Luk døren.

Rensning af fugtighedssensor

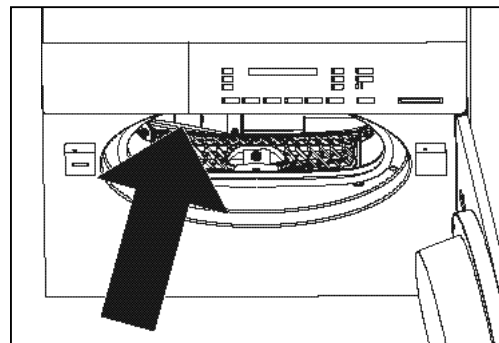

Efter længere tids drift kan der dannes fine aflejringer (kalk, skyllemiddel) på fugtighedssensorerne samt foran og på indersiden af tromlen.

- ⚠ Ved fugtighedsstyrede programmer kan dette resultere i, at det ønskede tørreresultat ikke opnås. Tør aflejringerne af med en klud opredet i eddike.

Grundindstillinger

Maskinen har en grundindstilling fra fabrikken. Disse funktioner kan tilpasses individuelle behov enten ved idriftsættelse eller senere.

Grundindstillingen kan kun ændres, hvis der ikke kører et program. For at ændre en grundindstilling holdes altid først programknapperne nede og derefter trykkes der på ilgangsknappen. De pågældende funktioner vises i displayet. Når programknappen holdes nede og der trykkes flere gange på ilgangsknappen , ændres meddelelsen.

Eksempel:



Funktion slukket



Funktion tændt

Tørringsgrad (fra fabrikken NORMAL)

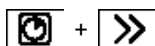

Er tørringsgraden «HØJERE» valgt, bliver tøjet i de fugtighedsstyrede programmer skabs- og ekstra tørt noget mere tørt.

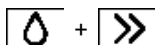

Anti-krøl (fra fabrikken 30MIN)

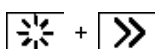

Med tændt funktion begynder i slutningen af programmet anti-krøl-fasen på maks. 60 minutter.

Indstilling af ur (uret er ikke indstillet fra fabrikken)



Med knappen  kan timerne indstilles og med knappen  kan minutterne indstilles.

Sprog (fra fabrikken TYSK)



Denne indstilling gælder midlertidigt for det valgte program og går efter nogle minutter efter programslut tilbage til udgangspunktet.

(Se «Udvidede grundindstillinger/Sprog»)

Udvidede grundindstillinger



► Ved at trykke samtidigt på disse tre knapper, vises de udvidede grundindstillinger.

► Ved gentaget tryk på  -knappen vises de mulige indstillinger.

► Ved at trykke på  -knappen kan indstillingerne ændres.

► Ved at trykke på  -knappen afsluttes visningen af indstillingerne.

Børnesikring (fra fabrikken OFF)

 Vælg «Udvidede grundindstillinger»!

Børnesikringen skal forhindre små børn i at starte, ændre eller slette et program ved et uheld.

Hold startknappen nede og tryk på ilgangsknappen:

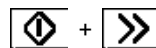

Hold startknappen nede og tryk på ilgangsknappen.

Tast-lagring (fra fabrikken OFF)

 Vælg «Udvidede grundindstillinger»!

Når tast-lagringsfunktion er tændt, lagres det sidst udførte specialprogram og vises ved næste tryk på  -knappen som det første igen på displayet. Ved gentaget tryk kan de følgende programmer vælges.

Et hyppigt benyttet specialprogram kan således vælges med et enkelt tryk på en tast.

Når funktionen ikke er tændt, vises som det første «Uld Finish»-programmet.

Lavere strømtilslutning (fra fabrikken OFF)

 Vælg «Yderligere grundindstillinger»!

Ved lavere tilslutningsspænding forlænges programtidene tilsvarende.

Off = 400 V 3N ~ 5,9 kW / 10 AT

On = 400 V 2N ~ 4,4 kW / 10 AT

LCD-lysstyrke (fra fabrikken 150)

 Vælg «Udvidede grundindstillinger»!

Med knappen  kan lysstyrke og skrift ændres på display.

LCD-kontrast (fra fabrikken 26)

 Vælg «Yderligere grundindstillinger»!

Med knappen  kan kontrasten på display ændres.

Alarmltone-lydstyrke (fra fabrikken LYDSTYRKE 2)

 Vælg «Udvidede grundindstillinger»!

Når alarmtonen er tilsluttet, lyder der ved programafslutning et signal med regelmæssige mellemrum.

Lydstyrken kan indstilles på tre trin:

Off

Lydstyrke 1

Lydstyrke 2

Lydstyrke 3

Standby-funktion (Fra fabrikken "On")

 Vælg «Udvidede grundindstillinger»!

Når stand-by-funktionen er tilsluttet, slår styringen over på energi-spare-tilstand, hvis der ikke kører et tørreprogram.



Optisk interface (fra fabrikken OFF)

 Vælg «Udvidede grundindstillinger»!

Når det optiske interface (SCS) er tilsluttet, kan kundeservice kommunikere med maskinen via en pc.

Sprog (fra fabrikken TYSK)

 Vælg «Udvidede grundindstillinger»!

Vælges med tast  og  midlertidigt et andet sprog, ændres indstillingen 4 minutter efter programslut, i standby eller efter længere tids stilstand tilbage til det fra fabrikken indstillede sprog.

Kontantkort

Indsættelse af kontantkort.

Indsæt kontantkortet med -symbolet op ad. I displayet vises efter hinanden «Saldo», «Acontobeløb», der fratrækkes samt «Ny saldo».

Et eventuelt tilgodehavende modregnes.

Er der ikke penge nok på kortet til at vaske «Saldo for lille». Desuden lyder der et signal. Differencen kan udlignes med et andet kontantkort.

Udtag kontantkort.

Vælg tørreprogram og start.

- ▶ Vælg tørreprogram
- ▶ Vælg ekstrafunktioner
- ▶ Start program

Meddelelser under programforløb

KOCH- BUNTWÄSCHE	00:35h
RESTGUTHABEN	2.60

Mens tørreprogrammet kører, vises skiftevis programtrin samt restbeløb.

Programafslutning

Når tørreprogrammet er slut, lagres restbeløbet i maskinen på det pågældende kontantkort. Dette tilgodehavende modregnes ved næste vasketur.

Programafslutningen vises ved tidsangivelsen 00:00h samt ved «Åbn dør».

Tilbageførsel af tilgodehavende



Tilbageførsel af tilgodehavende på kontantkortet kan med fordel foretages, når vaskedagen er slut.

▶ Indsæt kontantkort. I displayet vises den «Saldo», der er lagret på kortet.

▶ Tilbageførsel ved at trykke på ilgangsknappen.

I displayet vises efter hinanden «Tilgodehavende» (som krediteres) samt «Ny saldo».

▶ Udtag kontantkort.



Der kan kun foretages tilbageførsel på det kontantkort, hvorfra beløbet oprindeligt blev trukket.



Med aktiv børnesikring:

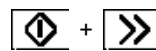

Overførsel af restbeløb

Er restbeløbet på kontantkortet for lille til at udligne acontobeløbet, meldes dette med et fløjtesignal samt der vises «Saldo for lille». Ved at indsætte et andet kort kan differencen udlignes.

Fejl

- ⚠ Reparationer, ændringer eller indgreb i elektriske maskiner må kun udføres af uddannede fagfolk. Ukorrekte reparationer kan medføre betydelige skader på maskinen samt udsætte brugeren for fare.
- ⚠ Ved reparationer må der kun isættes originale reservedele.

Små fejl, De selv kan udbedre

Makinen starter ikke efter, at der er trykket på en programknap:

- ▶ Kontrollér, om der er tændt på vægkontakten og stikket er sat i.
- ▶ Kontrollér, om alle sikringer er intakte eller den automatiske sikkerhedsfrakobling er aktiveret.

Maskinen starter ikke.

- ▶ Der er ikke trykket på startknappen.
- ▶ Starttidspunkt er indstillet. Starter først efter udløb af det indtastede starttidspunkt.

Det ønskede tørreresultat blev ikke opnået.

- ▶ Rens filter.
- ▶ Tørringsgrad forhøjes. (Se side 14)
- ▶ Fugtighedssensor renses. (Se side 13)

Tørretiden er for lang.

- ▶ Rens filter.
- ▶ Strømfald (bemærk spærretider).

Tøjet bliver ikke tørt ved den højst mulige indstilling.

- ▶ For meget tøj i tromle.
- ▶ Tøj ikke centrifugeret tilstrækkeligt.
- ▶ Rum er ikke tilstrækkeligt ventileret (dør eller vindue åbnes).
- ▶ Filter stoppet af fnug (filter renses).

Tromlebelysning fungerer ikke.

- ▶ Pære defekt. Af sikkerhedsgrunde må pæren kun udskiftes af fagfolk.

Fugtighed i rummet er stærkt stigende.

- ▶ Rum er ikke tilstrækkeligt ventileret. Sørg for tilstrækkelig ventilation.

Dør går ikke op:

- ▶ Skulle der ikke være nogen strøm, når dør skal åbnes, kan døren åbnes manuelt med et kort tryk på højde med dørlåsen

Fejlmeldinger

Ved de følgende fejlmeddelelser kan programmet genstartes ved at trykke på startknappen, efter at fejlen er afhjulpet.

«BØRNESIKRING AKTIV»

- ▶ Hold startknappen nede og tryk på ilgangsknappen.

«LUK DØREN»

- ▶ Dør trykkes i, til låsen lukker korrekt.

«KONTROL AF VARMETRIN»

- ▶ Der lyder et signal og programmet kører videre. Fejlmeldingen «Kontrollér varmetrin» vises på display og bliver stående, til programmet er slut. Tryk én gang på startknappen og derefter flere gange på ilgangsknappen, indtil meddelelsen «Program slut» vises.
- ▶ Kontrollér, om alle temperaturkontakter er tændt. Tryk én gang med fingeren på alle 3 runde gummirør (se billede). Er problemet ikke løst efter at have trykket én gang på dem, kontakt da kundeservice.

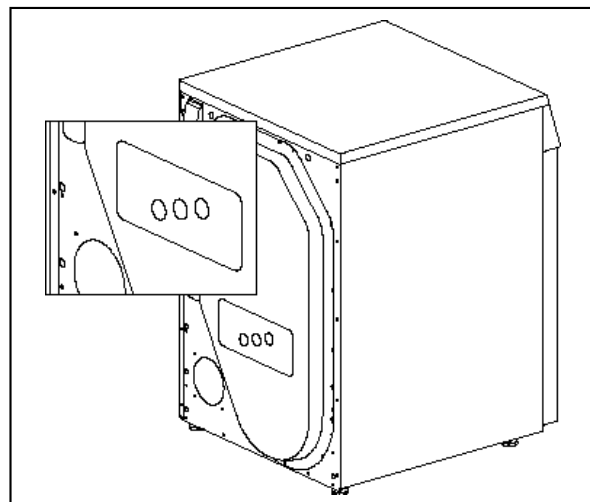

Hvis maskinen viser fejl F-- :

- ▶ Afbryd programmet med ilgangstasten og vælg et nyt program.

Ved gentagen fejlmeddelelse:

- ▶ Strømtilførsel afbrydes i ca. 1 minut og tilsluttes igen (Træk stikket ud).
- Maskinen er klar til brug igen, når alle kontrollamper for programmerne blinker.
- ▶ Vælg et nyt program.

Hvis fejlen optræder igen:

- ▶ Notér fejlmeddelelsen.
- ▶ Træk stikket ud eller sluk på vægkontakt.
- ▶ Kontakt kundeservice.

Fejlmeddelelser (kontantkort)

Nedennævnte fejlmeddelelser relaterer til kontantkortet.

Forkert kortside

- Indsæt kontantkort med -symbolet op ad.

Kort tomt

- Benyt opladet kontantkort.

Kontantkort ugyldigt

- Det anvendte kontantkort er ikke tilladt.
Den ansvarlige for vaskeriet underrettes.

Isæt kontantkort igen.

- Vent 5 sekunder, til a-conto-beløbet er ajourført og den nye saldo på kortet vises.

Kundeservice

Før De ringer til kundeservice, prøv da, om De eventuelt selv kan afhjælpe fejlen (se «Små fejl, De selv kan udbedre» side 16).

Hvis De har brug for rådgivning, også i garantiperioden, skal De betale for montørens arbejds løn i denne forbindelse.



Kan De ikke selv afhjælpe fejlen, træk da stikket ud eller sluk på vægkontakten og ring til kundeservice. Hav venligst produkt- og maskinnummer parat til kundeservice.

Disse angivelser står på typeskiltet på indersiden af lugen.

Notér her nedenfor numrene på Deres maskine.

Produkt-nr. _____

Maskin-nr. _____

Sommaire

Remarques importantes	
▶ Conseils pour la mise au rebut	20
▷ Emballage de votre nouvelle machine	20
▷ Machine usagée	20
▶ Consignes de sécurité et avertissements	20
▶ Protection de l'environnement et économies d'énergie	20
Votre nouveau sèche-linge	
▶ Description de la machine	21
▶ Conseils sur le linge	22
▷ Tri du linge	22
▷ Conseils pour le séchage	22
Mise en service	
▶ Préparation	22
▶ Ouverture de la porte	22
▶ Chargement du linge	22
▶ Fermeture de la porte	22
Séchage	
▶ Tableau des programmes	23/24
▶ Séchage	25
▷ Programmes séchage	25
▷ Programme express	25
▷ Programme mixte	25
▷ Programmes chronométrés	25
▷ Programmes spéciaux	25
▷ Sélection de fonctions additionnelles	25
▷ Démarrage du programme	25
▷ Déroulement/Etat du programme	25
▷ Modification du programme	26
▷ Interruption du programme	26
▷ Rajout de linge	26
▷ Fin du programme	26
▷ Enlèvement du linge	26
▷ Mise hors tension de l'appareil	26
▶ Fonctions additionnelles	26
▷ Linge d'entretien facile	26
▷ Démarrage différé	26
▷ Séchage douceur	26
▷ Séchage extra douceur	26
▷ Marche rapide	26
Entretien/Maintenance/Nettoyage	
▶ Nettoyage de l'appareil	27
▷ Nettoyage du filtre	27
▷ Nettoyage du capteur d'humidité	27
Réglages de base	
▶ Degré de séchage	28
▶ Dispositif anti-froissage	28
▶ Réglage de l'heure	28
▶ Langue	28
▶ Réglages de base étendus	28
▷ Sécurité enfants	28
▷ Mémorisation des touches	28
▷ Puissance raccordée réduite	28
▷ Luminosité/Contraste de l'affichage LCD	

28

▷ Signal sonore	29
▷ Fonction Standby	29
▷ Interface optique	29
▷ Langue par défaut	29

Cash-Card

▶ Insertion de la Cash-Card	29
▶ Retrait de la Cash-Card	29
▶ Sélection du programme de lavage	29
▶ Affichage pend. le déroulem. du programme	29
▶ Fin du programme	29
▶ Récupération du solde	29
▶ Transfert de crédit	29

Pannes

▶ Remédier soi-même aux petites pannes	30
▶ Messages de panne	30/31

Service après-vente

▶ N° du produit et de la machine	31
----------------------------------	----

Garantie

31

Notes

32

Inhaltsverzeichnis Deutsch

▶ Siehe Seite	5
---------------	---

Sommario italiano

▶ Vedere pagina	33
-----------------	----

Contents english

▶ See page	47
------------	----

Conseils pour la mise au rebut

Emballage de votre nouvel appareil

- ⚠ Débarressez-vous de l'emballage comme il se doit.
- ⚠ Les matériaux de l'emballage ne sont pas des jouets.
Le recyclage de l'emballage permet d'épargner des matières premières et de réduire les volumes de déchets.
L'emballage pourra être restitué au commerçant spécialisé ou au fournisseur.
Tous les matériaux d'emballage utilisés sont écologiques et recyclables. Le carton est constitué de 80 à 100% de vieux papiers.
Les pièces en bois n'ont pas été traitées chimiquement. Les feuilles sont en polyéthylène (PE); les banderoles, en polypropylène (PP). Ces matériaux, recyclables, sont exclusivement des composés d'hydrocarbures.

Anciens appareils

- ⚠ Les appareils mis au rebut doivent être rendus inutilisables.

Après avoir tiré la fiche réseau, ou fait défaire le branchement par l'électricien, sectionnez et enlevez le câble de réseau. Détruisez la serrure pour éviter que, en jouant, des enfants s'y enferment et mettent leur vie en danger.

Le symbole  sur le produit ou sur son emballage indique que ce produit ne doit pas être traité comme un déchet ménager classique, mais déposé dans un centre de collecte pour le recyclage d'appareils électriques et électroniques. En participant à l'élimination appropriée de ce produit, vous protégez l'environnement et la santé d'autrui. L'environnement et la santé sont mis en danger par une mauvaise élimination

Votre ancien appareil contient des matières précieuses, qu'il convient d'envoyer au recyclage. Vous trouverez davantage d'informations sur le recyclage de ce produit en vous adressant à votre commune, au service d'enlèvement des ordures ou au magasin dans lequel vous avez acheté le produit.



Où déposer les anciens appareils?

Dans tous les points de vente de nouveaux appareils, dans les centres de collecte S.EN.S officiels ou auprès des entreprises de récupération S.EN.S officielles. Vous trouverez la liste des centres de collecte SENS sur le site www.sens.ch

Conseils de sécurité et consignes

Cet appareil est conforme aux normes de sécurité des appareils électriques.

À observer avant la mise en service!

- ⚠ Lisez attentivement les notices jointes avant de mettre en service votre séchoir. Elles contiennent des informations importantes pour l'installation, l'utilisation et la sécurité de l'appareil.
- ⚠ Les réparations sont de la compétence exclusive du personnel technique dûment formé.

Mal effectuées, elles peuvent entraîner de notables dégâts matériels et de graves dangers pour l'utilisateur.

- ⚠ Conservez soigneusement les notices, à l'intention des autres utilisateurs actuels et futurs.
- ⚠ Installez l'appareil conformément aux instructions de montage.
- ⚠ Ne branchez pas un appareil visiblement endommagé. En cas de doute, posez la question au service après-vente ou au revendeur.

À observer lors du séchage:

- ⚠ Ne laissez pas d'enfants sans surveillance à proximité de l'appareil.
- ⚠ Éloignez les animaux domestiques de l'appareil.
- ⚠ N'utilisez l'appareil qu'en milieu domestique, pour sécher des textiles.

À observer après la fin du programme:

- ⚠ Ne mettez pas la main dans le tambour lorsqu'il tourne.

À observer pour protéger l'appareil:

- ⚠ Ne grimpez pas sur l'appareil.
- ⚠ Ne vous asseyez pas et ne vous appuyez pas sur la porte (danger de basculement!).

À observer lors du transport:

- ⚠ Attention lors du transport de l'appareil! (risque de blessure!)
Ne soulevez pas l'appareil avec les parties avant!

Protection de l'environnement et économie d'énergie

Economie de courant, de temps et d'argent

- ▶ Vous séchez avec le maximum d'économie, et en préservant au mieux l'environnement, si vous chargez la machine avec le plus possible de linge.
- ▶ Ne dépassez cependant pas les quantités maximales indiquées. (V. le tableau des programmes, p. 23/24).
- ▶ Avant le séchage, débarressez complètement le linge de son eau par essorage dans une machine à laver automatique ou uneessoreuse. Plus la vitesse d'essorage sera élevée, plus le temps de séchage sera bref, et moins vous consommerez d'électricité.
- ▶ Essorez également le linge d'entretien facile.
- ▶ Lors du séchage, il faut assurer une bonne aération de la pièce (ouvrez les fenêtres ou la porte).
- ▶ Nettoyez le filtre après chaque séchage.
- ▶ Maintenez le filtre à air bien propre.
- ▶ Ne couvrez et ne collez pas la grille d'air de refroidissement, afin de permettre l'aspiration d'une quantité

Description de la machine

Commandes et affichage

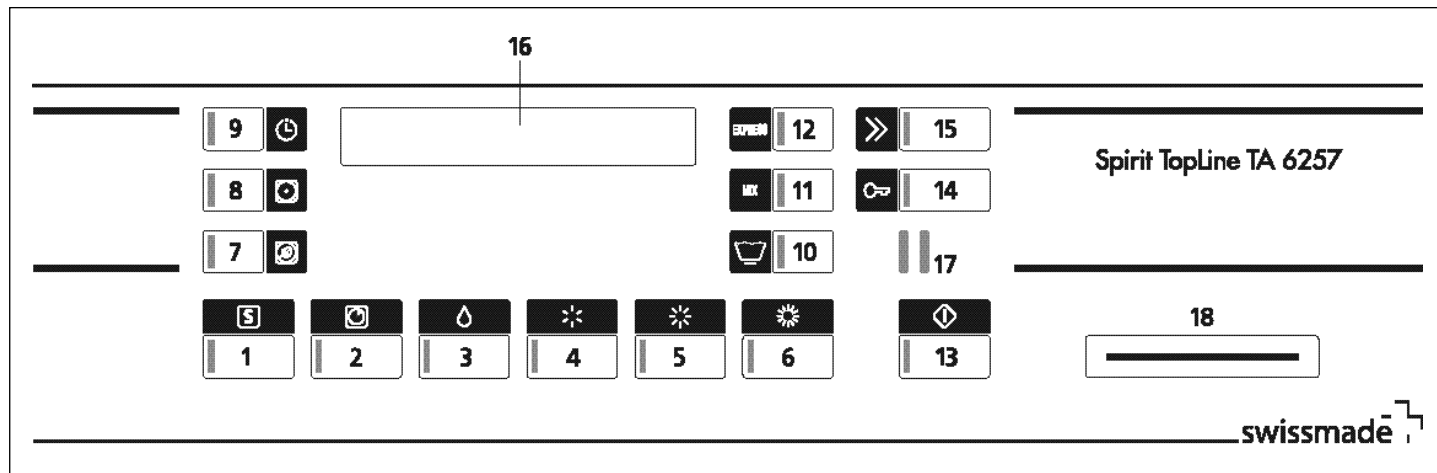

Programmes

- 1 Programmes spéciaux
- 2 Programme chronométré
- 3 Prêt à repasser
- 4 Légèrement sec
- 5 Prêt à ranger
- 6 Très sec
- 11 Linge mélangé
- 12 Express

Affichages

- 16 Afficheur

Interfaces

- 17 SCS-Schulthess Control System (interface PC pour le S.A.V.)
- 18 Rainure pour la Cash-Card (Option)

Fonctions additionnelles

- 7 Séchage extra douceur
- 8 Linge délicat
- 9 Démarrage différé
- 10 Linge d'entretien facile
- 13 Démarrage du programme
- 14 Ouverture de la porte
- 15 Marche rapide

Commandes et affichage

Filtre

Porte

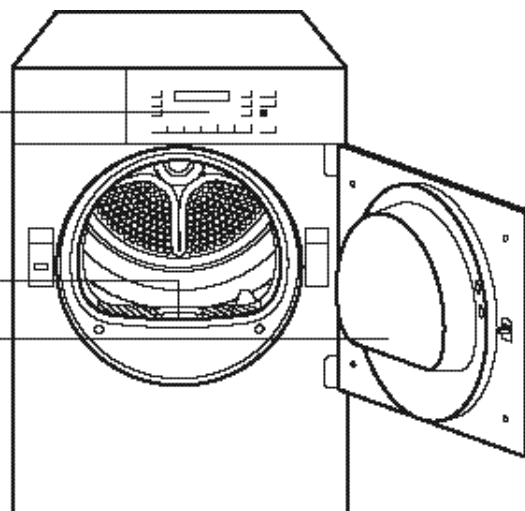

Conseils sur le linge

Tri du linge

 Tenez compte des symboles d'entretien figurant sur les textiles.



Séchage à température normale.



Séchage à basse température.



Ne pas sécher à la machine.

 Ne pas sécher à la machine les textiles suivants:

- la laine et les tissus à base de laine (excepté avec le programme spécial «Finition Laine»): danger de feutrage!
- les tissus fragiles (soie, rideaux en synthétique, etc.): risque de froissage!
- le linge dégoulinant: gaspillage d'énergie!

► Afin d'obtenir un résultat de séchage uniforme, triezy le linge selon le type de tissu et l'objectif de séchage désiré.

Ne dépassez pas les quantités maximales, car la surcharge nuit au résultat du séchage et le linge sera complètement froissé.

Conseils pour le séchage

► Fermez fermetures-éclair, crochets et oeilleys. Bouctonnez les housses de duvet et coussins. Nouez les rubans de tablier et les ceintures qui sont détachées, etc.

► Pour les tissus d'entretien facile, sortez-les de l'appareil, si possible, à l'état légèrement humide (objectif de séchage: «Légèrement sec»), et complétez par un bref séchage à l'air. Un séchage excessif entraîne des risques de froissage.

► Les pièces de linge encore trop humides après le séchage d'un lot à base de types de tissu très différents peuvent subir un complément de séchage en programme chronométré .

► Les textiles tricotés peuvent rétrécir un peu au séchage. Ne pas utiliser le programme «Extra sec»  pour ces matériaux.

Mise en service

 Installez la machine conformément aux instructions de montage.
Avant de mettre la machine en service pour la première fois, essuyer le tambour au moyen d'un linge humide.

Préparation

Vérifiez:

- si le filtre à peluches est en place (v. entretien/maintenance/nettoyage, p. 27);
- si la fiche réseau est branchée, ou si l'interrupteur mural est allumé;

L'appareil est prêt à l'emploi dès que tous les témoins de contrôle sont allumés ou éteints en mode repos. Si un témoin reste allumé en permanence, procédez comme suit:

- pressez la touche de marche rapide jusqu'à ce que le programme s'achève et que le témoin correspondant s'allume. Attendez qu'il se mette à clignoter et pressez la touche «Ouvrir» (enlever éventuellement le linge).

Ouverture de la porte



► Pressez la touche «Ouvrir».

- La porte s'ouvre d'un coup.

► Attention: elle ne s'ouvre que si l'alimentation principale en courant est assurée. Si, avant l'ouverture de la porte, il n'y a plus de courant (par exemple, les pièces de monnaie sont épuisées), il est possible d'ouvrir la porte manuellement en appuyant brièvement au niveau du verrou de fermeture.

- L'éclairage du tambour s'allume à l'ouverture de la porte.

Chargement du linge

 Avant de charger le linge, assurez-vous qu'aucun corps étranger n'est présent dans le tambour, ou même que des animaux y sont enfermés.

 Ne séchez dans l'appareil que des textiles ayant été lavés à l'eau.

 Ne pas introduire des pièces de linge traitées préalablement avec des nettoyants inflammables (détachants ou white-spirit par ex.). Risque d'explosion!

 Ne séchez pas dans l'appareil des textiles contenant du caoutchouc mousse ou ayant été tachés par du fixatif pour cheveux, du dissolvant pour vernis à ongles ou des produits similaires (danger d'incendie!).

► Placez le linge de façon bien aérée dans le tambour, petites et grandes pièces mélangées.

Fermeture de la porte

► Fermez la porte, en la poussant en position jusqu'à ce que la fermeture émette un déclic audible.

► Veillez à ce qu'aucune pièce de linge ne reste coincée lors de la fermeture de la porte.

 Si la porte n'est pas fermée, un interrupteur de sécurité empêche la mise en service de l'appareil.

Tableau des programmes

Conseil d'entretien	Quantité max. de linge	Textiles/type de linge	Programmes Objectifs de séchage	Touches de sélection des programmes	Vitesse d'essorage dans la machine à laver t/min.	Consomm. d'électricité kWh, env.	Durée approx. en min.
Blanc/Couleurs en coton ou en lin							
	7 kg	<ul style="list-style-type: none"> Literie et linge de table, serviettes, t-shirts, polos, vêtements de travail T-shirts, polos, robes, pantalons, vêtements de travail, sous-vêtements chaussettes en coton Serviettes éponge, torchons à vaisselle, torchons à main, literie, sous-vêtements, Peignoirs et literie en tissu-éponge, pas les sous-vêtements et les chaussettes 	<p>▶ Pour linge à repasser au fer</p> <p>▶ Pour linge n'exigeant pas de repassage ou seulement un repassage léger</p> <p>▶ Pour linge n'exigeant pas de repassage</p> <p>▶ Pour tissus particulièrement épais ou en plusieurs couches</p>	 	<p>1400</p> <p>1000</p> <p>1400</p> <p>1000</p> <p>1400</p> <p>1000</p> <p>1400</p> <p>1000</p>	<p>2,4</p> <p>2,9</p> <p>3,0</p> <p>3,5</p> <p>3,3</p> <p>3,9</p> <p>3,6</p> <p>4,2</p>	<p>30</p> <p>35</p> <p>36</p> <p>41</p> <p>42</p> <p>47</p> <p>45</p> <p>50</p>
Linge d'entretien facile (sans repassage) en synthétique et fibres mélangées, ainsi qu'en coton à apprêt éliminant le repassage, tels que (viscose, fibre acrylique, polyester)							
	3,5 kg	<ul style="list-style-type: none"> Pantalons, robes, jupes, chemises Pantalons, robes, jupes, chemises, chemisiers, corsets, caleçons, vêtements de sport à forte quote-part de fibres synthétiques Chemises, chemisiers, vêtements de sport, literie et linge de table, survêtements Anoraks, couvertures 	<p>▶ Pour linge à repasser au fer</p> <p>▶ Pour linge n'exigeant pas de repassage ou seulement un repassage léger</p> <p>▶ Pour linge n'exigeant pas de repassage</p> <p>u Pour tissus particulièrement épais ou en plusieurs couches</p>	 	<p>800</p> <p>600</p> <p>800</p> <p>600</p> <p>800</p> <p>600</p> <p>800</p> <p>600</p>	<p>0,9</p> <p>1,1</p> <p>1,1</p> <p>1,3</p> <p>1,3</p> <p>1,6</p> <p>1,7</p> <p>1,9</p>	<p>17</p> <p>22</p> <p>23</p> <p>27</p> <p>27</p> <p>31</p> <p>33</p> <p>39</p>
Programmes spéciaux							
	2,3 kg	<ul style="list-style-type: none"> Vêtements de sport fibres synthétiques et mélangées 	<p>▶ Vêtements de sport et d'extérieur</p> <p>Le linge sort sec «prêt à ranger»</p>		600	1,4	33
	3,5 kg	<ul style="list-style-type: none"> Mixte Linge mélangé 	<p>▶ Coton et fibres mélangées</p> <p>Le linge sort super sec</p>		800 <p>600</p>	2,5 <p>2,7</p>	45 <p>50</p>
		<ul style="list-style-type: none"> Séchage chronométré Pièces de linge isolées Pièces de linge peu humides 	<p>▶ Pour finir de sécher des pièces de linge encore humides</p>				
		<p>▶ Pour les textiles sensibles aux températures, presser la touche «Linge délicat» ou «Séchage extra doux»</p>					
<p>Les valeurs de consommation et durées de programme indiquées sont orientatives et ont été déterminées en conditions normalisées. Des variations jusqu'à 10% sont possibles.</p> <p>Pour les appareils à puissance connectée réduite, demandez les durées de programme correspondantes.</p>							

Tableau des programmes

⚠ Beachten Sie stets die Pflegekennzeichen der Textilien

Conseil d'entretien	Quantité max. de linge	Textiles/type de linge	Programmes Objectifs de séchage	Touches de sélection des programmes	Vitesse d'essorage dans la machine à laver l/min.	Consomm. d'électricité kWh, env.	Durée approx. en min.	
Programmes spéciaux								
	3,5 kg	● Laine lavable en machine	► Le linge devient plus moelleux, mais sans sécher. Retirer le linge juste après la fin du programme et l'étendre sur une serviette-éponge pour qu'il sèche.	Finition laine Séchage délicat (seulement séchage initial)	800 1x	0,1	5	
	3,5 kg	● Jeans	► Les jeans et les pantalons en coton sont séchés jusqu'à «Prêt à repasser». Les étendre ensuite pour qu'ils séchent à l'air libre.	Jeans Prêt à repasser	400 2x	1,7	28	
	2,3 kg	● Chemises	► Les chemises et les chemisiers sont séchés jusqu'à «Prêt à repasser». Le programme minimise la formation de plis, prend soin du linge et facilite le repassage.	Chemises Prêt à repasser	Chemises 3x	400	1,1	
	2,3 kg	● Vêtements d'extérieur	► Pour sécher des vêtements d'extérieur, vestes en duvet etc.	Outdoor Prêt à ranger	600 4x	1,8	62	
	1 pièce	● Coussins (grands ou petits)	► Les coussins, vestes en duvet etc. sont séchés jusqu'à «Très sec». Le cas échéant, retourner les coussins au bout d'env. 120 min.	Oreillers Séchage chronométré 10-150 min.	600 5x	5,6	150	
	7 kg	● Serviettes	► Serviettes éponge, serviettes de bain, peignoirs etc. en coton	Serviettes Prêt à ranger	max. 1400 6x	3,7	43	
	7 kg	● Draps	► Draps de lit, draps housse, housses de couette, taies d'oreiller etc. en coton. Veuillez retourner les housses de duvet et coussins.	Draps Prêt à ranger	max. 1400 7x	3,7	48	
	⚠	Pour les textiles sensibles aux températures, presser la touche «Linge délicat» ou «Séchage extra doux»						

Les valeurs de consommation et durées de programme indiquées sont orientatives et ont été déterminées en conditions normalisées. Des variations jusqu'à 10% sont possibles. Pour les appareils à puissance connectée réduite, demandez les durées de programme correspondantes.

Séchage

Programmes séchage

Le système électronique de palpation, avec ses capteurs sensibles, évalue en continu le degré d'humidité momentané de votre linge, et met automatiquement fin au programme dès qu'est atteint l'objectif de séchage imposé.

Sélectionnez conformément au tableau le programme pour blanc/couleurs ou synthétiques.



- ▶ Pressez la touche de programme.
- Le témoin du programme choisi s'allume.
- ▶ Pour les tissus synthétiques, choisir la fonction additionnelle «Entretien facile» .

Programme express: 2,3 kg



Programme de séchage permettant de sécher rapidement du linge en fibres synthétiques (vêtements de sport en synthétique ou en fibres mélangées). Le linge sort prêt à ranger.

- ▶ Appuyer sur la touche «Programme».
- Le voyant s'allume.

Programme mixte: 3,5 kg



Vous permet de sécher du linge mélangé en coton et des textiles d'entretien facile. Le linge sortira très sec.

- ▶ Appuyer sur la touche «Programme».
- Le voyant s'allume.

Programmes chronométrés



Programme chronométré pour le séchage de pièces de linge individuelles ou comme complément de séchage pour textiles déjà séchés et à faible contenu d'humidité.

La durée de séchage sera choisie d'après le type et la quantité de linge ainsi qu'en fonction de l'humidité de celui-ci.

- ▶ Pressez la touche «Programme».
- Le témoin du programme chronométré s'allume, et la durée minimale de séchage, 10 min, s'affiche.
- ▶ Imposez la durée du séchage en pressant la touche de façon répétée, jusqu'à un maximum de 150 min.

Programmes spéciaux



Les programmes spéciaux servent à sécher correctement certains textiles. Appuyer plusieurs fois sur la touche , jusqu'à ce que le programme voulu s'affiche à l'écran (Voir tableau des programmes, page 24).

Sélection de fonctions additionnelles

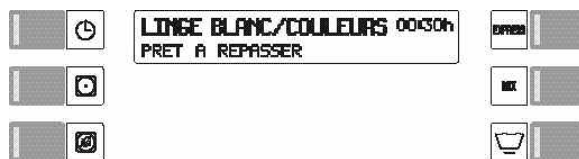

Une fois le programme sélectionné, on voit s'allumer les témoins des fonctions additionnelles pouvant être insérées en cas de besoin.

- ▶ Pressez la ou les touches de fonction désirées (v. fonctions additionnelles, p. 24).
- Le ou les témoins de la/des fonction(s) additionnelle(s) choisie(s) s'allume(nt).

Démarrage du programme



- ▶ Pressez la touche de démarrage.
- Le témoin s'allume, et le programme se déroule automatiquement.



Si la sécurité enfants est activée:

- ▶ Tout en tenant pressée la touche de marche rapide, agissez sur la touche de démarrage.

Déroulement du programme / état du programme

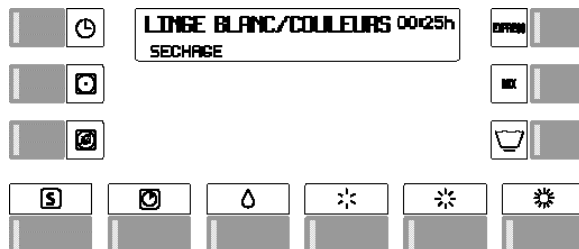

▶ Dans les programmes pilotés par le taux d'humidité, l'humidité du linge est constamment contrôlée par un système électronique de palpation.

- La durée restante du programme est affichée.

Ce temps restant est recalculé plusieurs fois au cours du cycle de séchage, la fin effective du programme varie donc de quelques minutes.

- ▶ Dans les programmes chronométrés, le temps restant demeure affiché jusqu'à la fin du programme.

Modification du programme avant son démarrage

- ▶ Pressez à nouveau la touche du programme désiré.
- Tous les témoins des fonctions additionnelles choisissables se remettent à clignoter, et tous les réglages sont effacés.
- ▶ Choisissez éventuellement les fonctions additionnelles.
- ▶ Mettez le programme en marche.

Interruption du programme



- ▶ Pour interrompre le programme, pressez à plusieurs reprises la touche de marche rapide, jusqu'à ce que le témoin «Fin de programme» clignote.



- Si la sécurité enfants est activée:
- ▶ Tenez pressée la touche de démarrage.
 - ▶ Appuyez en même temps sur la touche «Marche rapide».

Rajouts de linge

Possibles à tout moment.



- ▶ Pressez la touche d'ouverture de la porte.
- Le tambour s'arrête.
- ▶ Rajoutez le linge.
- ▶ Refermez la porte.
- ▶ Pressez la touche de démarrage.



- Sécurité enfants activée:
- ▶ Appuyer simultanément sur la touche «Start» et sur la touche «Marche rapide».
 - ▶ Le séchage reprend.

Fin du programme

La fin du programme est indiquée par la valeur 00:00h, le message «Fin du programme» à l'écran et le clignotement du voyant.

- Un signal résonne (seulement si le vibreur a été enclenché).
- ▶ Le dispositif anti-froissage est activé par défaut en usine. A la fin du programme, le tambour continue à tourner en alternance (pendant 30 ou 60 minutes) pour que le linge ne se froisse pas. C'est au plus tard à ce moment qu'il conviendra d'enlever le linge.

Enlèvement du linge



- ▶ Pressez la touche d'ouverture de la porte.
- L'éclairage s'allume dans le tambour.
- ▶ Enlevez le linge.
- ▶ Nettoyez le filtre (p. 27).
- ▶ Refermez la porte.

Mise hors service de l'appareil

- ▶ Eteignez l'interrupteur mural.

Fonctions additionnelles

Outre les divers programmes de séchage, votre séchoir à linge vous offre la possibilité de personnaliser ses programmes.

Le choix d'une ou plusieurs fonctions additionnelles vous permettra d'ajuster votre programme de séchage d'après les particularités spécifiques de votre linge.

- ▶ Vous avez en outre la possibilité d'adapter votre séchoir à vos besoins en modifiant ses réglages de base (v. p. 28).

Linge d'entretien facile



Pour les textiles d'entretien facile en tissu synthétique ou fibres mélangées, ainsi que pour le coton à apprêt éliminant le repassage.

Démarrage différé



En pressant une ou plusieurs fois la touche de démarrage différé, on peut retarder jusqu'à 23,5 heures le démarrage du programme. Ceci permet par ex. de profiter du tarif réduit de nuit pour l'électricité. On peut adapter le début et donc aussi la fin d'un programme à ses habitudes individuelles de vie. L'écran indique l'heure de démarrage et l'heure prévue de la fin du programme. Après avoir appuyé sur la touche de démarrage, le compte à rebours commence. Une fois l'heure de démarrage atteinte, le programme sélectionné démarre automatiquement et l'affichage indique la durée du programme.

Modifier le temps présélectionné

- Le temps présélectionné peut être annulé en appuyant sur le bouton de marche rapide. Une nouvelle heure de départ peut être sélectionnée.

Indications

- En cas de coupure de courant, le temps choisi demeure en mémoire. La durée de la coupure n'est pas prise en considération.

Séchage du linge délicat



La touche «Délicat» doit être enclenchée pour les textiles en synthétique et fibres mélangées sensibles aux températures, tels que acrylique, p.ex. La température est réduite et le temps de séchage un peu plus long.

Séchage extra douceur



Avec les textiles extrêmement délicats, vous pouvez appuyer sur la touche «Séchage extra douceur» pour réduire encore la température de séchage.

Marche rapide



On peut abréger ou interrompre le programme en pressant la touche de marche rapide.

(V. modification/interruption du programme)

Entretien/Maintenance/Nettoyage

Nettoyage de l'appareil

- ⚠ Avant toute opération d'entretien, maintenance ou nettoyage, assurez-vous que l'alimentation électrique a été coupée.
- ⚠ N'aspergez en aucun cas l'appareil avec de l'eau.
- ⚠ N'utilisez pas de solvants! Ces produits peuvent endommager des pièces de l'appareil, dégagent des vapeurs toxiques et engendrent un danger d'explosion!

Ne nettoyez le corps de l'appareil et les éléments de commande qu'au moyen d'eau savonneuse ou d'un nettoyant commercial non abrasif et exempt de solvants.

Nettoyage du filtre

Pendant l'emploi du linge, il se forme sur le linge, par frottement, des peluches. Celles-ci s'en détachent pendant le séchage et s'accumulent dans le filtre. Aussi faudra-t-il nettoyer ce filtre après chaque séchage.

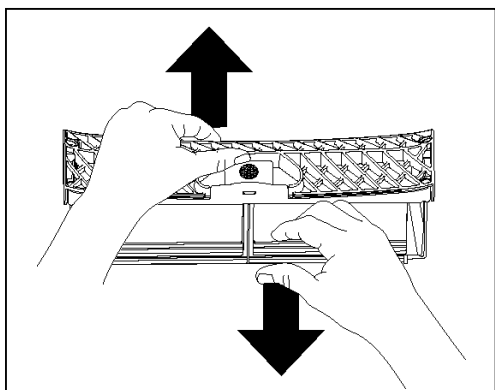
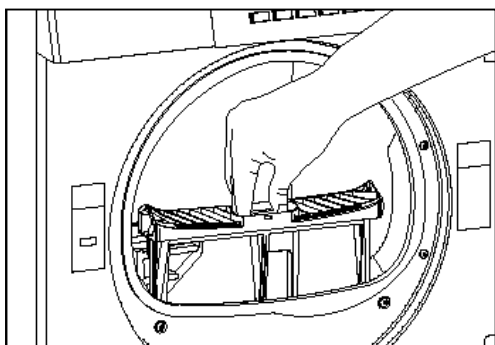

1. Pressez la touche pour ouvrir la porte.
2. Retirer le filtre et le déplier.
3. Passez la main sur le filtre: ceci en détachera les peluches. Il peut arriver qu'un filtre apparemment propre soit colmaté en raison d'un dépôt très fin et invisible dans les mailles du filtre. Tenez le filtre, l'une de ses surfaces étant orientée vers le haut, et versez un peu d'eau par-dessus. S'il ne laisse pas passer l'eau, il convient de le nettoyer par voie humide, éventuellement au moyen d'une brosse.

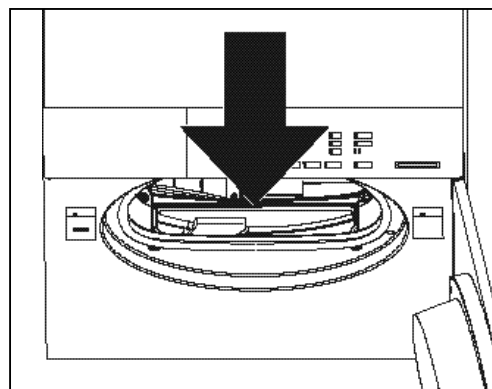

- 3.1 De temps à autre, veillez à éliminer les peluches s'accumulant à l'intérieur du support du filtre. Pour cela, utilisez un aspirateur ou un pinceau.
- 3.2 Introduisez le tube de l'aspirateur ou le pinceau de nettoyage dans l'ouverture du filtre à peluches. Enlevez toutes les peluches incrustées.
4. Remettez le filtre correctement en place.
5. Refermez la porte.

Nettoyage du capteur d'humidité

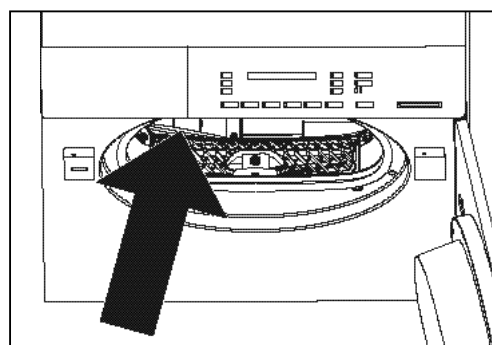

Après une certaine période de fonctionnement, des minces dépôts (calcaire, adoucissants) peuvent se former à la surface des capteurs d'humidité situés en façade à l'intérieur du tambour.



Lorsque vous utilisez un programme piloté par le taux d'humidité, ceci peut empêcher l'obtention du résultat de séchage désiré. Éliminer les dépôts en essuyant au moyen d'un linge imbibé de vinaigre.

Réglages de base

Le réglage de base de l'appareil a été effectué en usine, mais on peut l'adapter selon ses exigences individuelles, lors de la mise en service ou ultérieurement, au moyen des fonctions suivantes.

Les réglages de base ne peuvent être modifiés que si aucun programme de séchage n'est en cours. Pour modifier un réglage de base, il faut tout d'abord maintenir la/les touche(s) de programme enfoncée(s), puis appuyer sur la touche de marche rapide. Les fonctions correspondantes s'affichent alors sur l'afficheur numérique.

En appuyant de manière répétée sur la touche de marche rapide , la/le(s) touche(s) de programme demeurant enfoncée(s), l'affichage change.

Exemple:



Fonction désactivée



Fonction activée

Degré de séchage (en usine NORMAL)

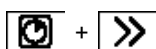

Si vous sélectionnez le degré de séchage «PLUS FORT», le linge sèche un peu plus avec les programmes pilotés par le taux d'humidité (Prêt à ranger et Extra sec).

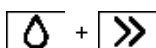

Dispositif anti-froissage (en usine 30MIN)

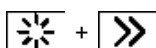

Lorsque la fonction est activée, la phase de défroissage de 60 minutes commence à la fin du programme.

Réglage de l'heure (non effectué en usine)



La touche  permet de régler les heures et la touche  les minutes.



Langue (en usine ALLEMAND)

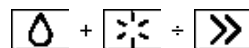

Ce réglage s'applique provisoirement au programme sélectionné et revient à la langue par défaut quelques minutes après la fin du programme. (Voir «Réglages de base étendus/langue par défaut»)

Réglages de base étendus



- ▶ Pour accéder aux autres réglages de base, appuyer simultanément sur ces trois touches.
- ▶ Une pression répétée sur la touche  montre les réglages possibles.
- ▶ Pour modifier les réglages, appuyer sur la touche .
- ▶ Pour mettre fin à l'affichage des réglages, appuyer sur la touche .

Sécurité enfants (en usine OFF)

 Sélectionner «Réglages de base étendus»!

La sécurité enfants vous protège contre tout démarrage, modification ou annulation fortuite(s) du programme par les enfants.

Démarrage d'un programme lorsque la sécurité enfants est activée:

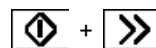

Maintenir la touche «Start» enfoncée et appuyez sur la touche «Marche rapide».

Mémorisation des touches (en usine OFF)

 Sélectionner «Réglages de base étendus»!

Si la fonction d'enregistrement est activée, le dernier programme spécial exécuté est mémorisé et apparaît en premier à l'écran lors d'une prochaine pression sur la touche . Une pression répétée permet de sélectionner successivement les programmes suivants.

Cela permet d'accéder par pression sur une seule touche à un programme spécial utilisé fréquemment.

Si cette fonction est désactivée, le premier programme affiché est «Finition laine».

Puissance raccordée réduite (en usine OFF)

 Sélectionner «Réglages de base étendus»!

Sur les machines disposant d'une puissance raccordée réduite, la durée des programmes se prolonge en conséquence.

Off = 400 V 3N ~ 5,9 kW / 10 AT

On = 400 V 2N ~ 4,4 kW / 10 AT

Luminosité de l'affichage LCD (en usine 150)

 Sélectionner «Réglages de base étendus»!

La touche  permet de régler la luminosité ou la police de l'affichage.

Contraste de l'affichage LCD (en usine 26)

 Sélectionner «Réglages de base étendus»!

La touche  permet de régler le contraste de l'affichage.

Volume du signal sonore (en usine SUR2)

- ⚠ Sélectionner «Réglages de base étendus»!

Signal sonore activé, la fin du programme est indiquée par un signal acoustique retentissant à intervalles réguliers.

Le volume de ce signal peut être réglé sur 3 niveaux à l'aide de la touche.

Off

Volume 1

Volume 2

Volume 3

Fonction Standby (en usine ON)

- ⚠ Sélectionner «Réglages de base étendus»!

Fonction Standby activée, la commande met la machine en mode économie d'énergie si aucun programme de séchage n'est en cours. Tous les affichages sont alors éteints.



Interface optique (en usine OFF)

- ⚠ Sélectionner «Réglages de base étendus»!

Interface optique (SCS) activée, le S.A.V. peut communiquer avec la machine via un PC.

Langue par défaut (en usine ALLEMAND)

- ⚠ Sélectionner «Réglages de base étendus»!

Si une autre langue est sélectionnée provisoirement à l'aide des touches  et  le réglage revient à la langue par défaut 4 minutes après la fin du programme, dans le mode veille ou après un arrêt prolongé.

Cash-Card

Insertion de la Cash-Card

Insérez la Cash-Card avec le symbole  dirigé vers le haut. Sur le display s'affichent successivement le «solde» mémorisé sur la Cash-Card, le montant de l'acompte qui sera déduit ainsi que le «solde nouveau». L'éventuel solde demeuré dans l'appareil sera pris en compte.

Si le montant disponible sur la Cash-Card n'est pas suffisant pour le lavage, le message «solde insuffisant» apparaît et un signal retentit. On pourra régler la différence au moyen d'une seconde Cash-Card.

Retrait de la Cash-Card

Sélection et démarrage du programme de séchage

- ▶ Choisissez le programme
- ▶ Choisissez les fonctions additionnelles
- ▶ Lancez le programme

Affichage pendant le déroulement du programme

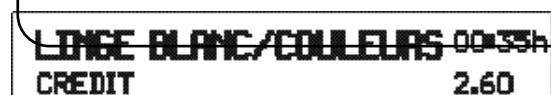

Pendant le programme de séchage apparaîtront tantôt les étapes de lavage, tantôt le solde.

Fin du programme

Dès qu'est achevé le programme de séchage, le solde demeurant dans l'appareil est mémorisé sous la Cash-Card correspondante. Il sera pris en compte lors du cycle

de lavage suivant. La fin du programme est indiquée par l'affichage sur le visuel du temps 00:00h ainsi que du message «ouvrez la porte».

Récupération du solde

-  Il conviendra de récupérer le solde sur la Cash-Card au terme d'un jour de lessive.

- ▶ Insérez la Cash-Card. Sur le display s'affiche le solde mémorisé sur la Cash-Card.
- ▶ Récupérez le solde en pressant la touche de marche rapide. Sur le display s'affichent successivement les messages «solde» qui sera récupéré ainsi que le «nouveau solde».
- ▶ Enlevez la Cash-Card.

- ⚠ La restitution ne peut avoir lieu, dans tous les cas, que sur la Cash-Card sur laquelle le montant a été débité à l'origine.

- ⚠ Si la sécurité enfants est enclenchée:

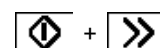

Transfert de crédit

Si sur une Cash-Card, le montant restant est insuffisant pour régler le décompte, un signal sonore retentit et le message «solde insuffisant» s'affiche sur l'écran. Le montant encore à payer apparaît. La différence peut être réglée par l'introduction d'une seconde Cash-Card.

Pannes

- ⚠ Les réparations, modifications et interventions sur des appareils électriques ne doivent être effectuées que par du personnel spécialisé dûment formé. Des réparations mal faites peuvent entraîner de considérables dommages matériels et des risques élevés pour l'utilisateur.
- ⚠ On utilisera seulement des pièces originales lors des réparations.

Réparer soi-même les petites pannes

L'appareil ne se met pas en marche après avoir pressé une touche de programme:

- ▶ Vérifiez si l'interrupteur mural est allumé, et si la fiche réseau est branchée.
- ▶ Vérifiez si tous les fusibles sont intacts et si le disjoncteur automatique ne s'est pas déclenché.

L'appareil ne démarre pas:

- ▶ Touche de démarrage non actionnée.
- ▶ Démarrage différé inséré. Le démarrage n'aura lieu qu'après le retard imposé.

Le séchage attendu n'est pas atteint.

- ▶ Nettoyer le filtre
- ▶ Augmenter le degré de séchage (voir page 28).
- ▶ Nettoyer le capteur d'humidité (voir page 27).

Le séchage dure trop longtemps.

- ▶ Nettoyer le filtre.
- ▶ Coupure de courant (heures de coupure des compagnies électriques).

Le linge n'est pas sec même à la puissance maximale de séchage possible.

- ▶ Tambour surchargé.
- ▶ Linge insuffisamment essoré.
- ▶ Aération de la pièce insuffisante (ouvrir porte et fenêtre).
- ▶ Filtre bouché par des peluches (le nettoyer).

L'éclairage ne s'allume pas dans le tambour.

- ▶ Ampoule défectueuse. Pour des raisons de sécurité, elle ne pourra être remplacée que par le service après-vente ou par un technicien.

L'humidité monte fortement dans le local.

- ▶ Local pas assez aéré. Assurez une ventilation suffisante.

La porte ne s'ouvre pas:

- ▶ Si, avant l'ouverture de la porte, il n'y a plus de courant (par exemple, les pièces de monnaie sont épuisées), il est possible d'ouvrir la porte manuellement en appuyant brièvement au niveau du verrou de fermeture.

Messages de panne

En présence des messages de panne suivants, on peut remettre le programme en marche en pressant la touche de démarrage, après élimination des pannes.

«SÉCURITÉ ENFANTS ACTIVÉE»

- ▶ Appuyer simultanément sur la touche de démarrage et sur la touche «Marche rapide».

«FERMER LA PORTE»

- ▶ Poussez sur la porte jusqu'à ce que la fermeture s'enclenche correctement.

«VÉRIFIER ALLURE CHAUFFE»

- ▶ Un signal retentit et le programme continue à se dérouler.

Le message d'erreur «Vérifier allure chauffe» apparaît sur l'écran et reste là jusqu'à la fin du programme.

Appuyer une fois sur le bouton de démarrage et plusieurs fois sur le bouton à marche rapide jusqu'à ce que le message «Fin du programme» soit affiché.

- ▶ Vérifiez le bon enclenchement de tous les contacteurs de température. Appuyez 1 fois sur chacune des 3 gaines rondes en caoutchouc (voir fig.). Si le problème persiste après 1 pression, veuillez en informer le S.A.V.

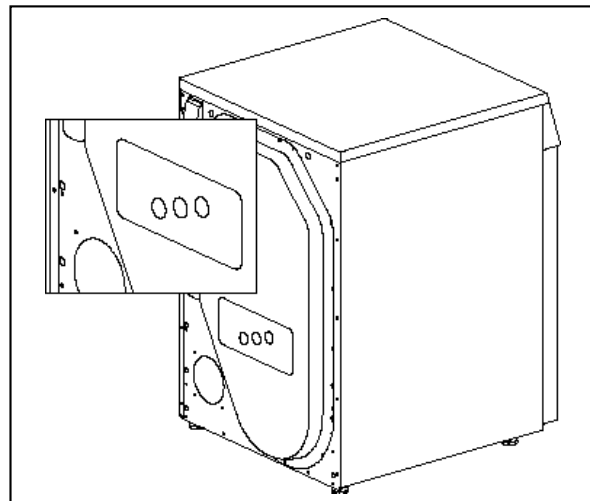

Si l'appareil affiche une panne de fonctionnement F- -:

- ▶ Interrompez le programme au moyen de la touche «Marche rapide» et choisissez un nouveau programme.

En cas de message répété de panne:

- ▶ Coupez l'alimentation électrique pendant 1 minute environ, puis rétablissez-la. (Retirez la fiche réseau ou fermez l'interrupteur mural)

L'appareil est de nouveau prêt à fonctionner dès que les témoins des programmes clignotent.

- ▶ Choisissez un nouveau programme.

Si le message de panne se répète encore:

- ▶ Notez le message de panne.
- ▶ Fermez le robinet de l'eau et retirez la fiche réseau ou fermez l'interrupteur mural.
- ▶ Informez le service après-vente.

Indice

Da tenere sempre in considerazione	
▶ Consigli per il riciclo	34
▷ Imballaggio della nuova asciugatrice	34
▷ La vostra vecchia asciugatrice	34
▶ Indicazioni per la sicurezza e avvertenze	34
▶ Rispetto per l'ambiente e consigli per risparmiare	34

La vostra nuova asciugatrice	
▶ Descrizione dell'asciugatrice	35
▶ Consigli per il bucato	36
▷ Assortimento dei capi	36
▷ Consigli per l'asciugatura	36

Messa in funzione	
▶ Operazioni preliminari	36
▶ Apertura dello sportello	36
▶ Introduzione della biancheria	36
▶ Chiusura dello sportello	36

Come asciugare	
▶ Tabella dei programmi	37/38
▶ Asciugazione	39
▷ Programmi elettronici	39
▷ Programma Espresso	39
▷ Programma misto	39
▷ Programmi a tempo	39
▷ Programmi speciali	39
▷ Selezione di funzioni supplementari	39
▷ Avvio del programma	39
▷ Durata e fase di svolgimento del programma	39
▷ Cambiamento di programma	40
▷ Interruzione del programma	40
▷ Aggiunta di biancheria	40
▷ Fine del programma	40
▷ Estrazione della biancheria	40
▷ Spegnimento dell'asciugatrice	40
▶ Funzioni supplementari	40
▷ Capi normali	40
▷ Impostazione timer	40
▷ Asciugatura delicata	40
▷ Asciugatura delicata extra	40
▷ Ciclo veloce	40

Manutenzione/Cura/Pulizia	
▶ Pulizia dell'apparecchio	41
▷ Pulizia del filtro	41
▷ Pulizia dei rilevatori d'umidità	41

Impostazione di base	
▶ Grado d'asciugatura	42
▶ Protezione antipiega	42
▶ Regolazione dell'ora	42
▶ Lingua	42
▶ Altre impostazione di base	42
▷ Dispositivo di sicurezza per i bambini	42
▷ Memoria tasti	42
▷ Tensione di allacciamento ridotta	42

▷ Luminosità/Contrasto del display	42
▷ Cicalino	43
▷ Funzione di standby	43
▷ Interfaccia ottica	43
▷ Lingua di default	43

Cash-Card	
▶ Introduzione della cash-card	43
▶ Ritiro della cash-card	43
▶ Selezione del programma di lavaggio	43
▶ Visualizzazioni durante lo svolgimento del programma	43
▶ Fine del programma	43
▶ Recupero	43
▶ Utilizzo del resto sulla carta	43

Anomalie di funzionamento	
▶ Eliminazione in proprio di piccole anomalie	44
▶ Segnalazioni di guasto	44/45

Servizio assistenza	
▶ Numero di prodotto e di macchina	45

Garanzia	45
----------	----

Appunti	46
---------	----

Inhaltsverzeichnis Deutsch

▶ Siehe Seite	5
---------------	---

Sommaire français

▶ Voir page	19
-------------	----

Contents english

▶ See page	47
------------	----

Consigli per il riciclo

Imballaggio dell'asciugatrice nuova

- ⚠ Smaltire il materiale d'imballaggio secondo le norme.
- ⚠ Il materiale d'imballaggio non è un giocattolo.
Attraverso il suo trattamento e recupero si risparmiano materie prime e si riduce il volume dei rifiuti. L'imballaggio può essere restituito al rivenditore o al fornitore.
Tutti i materiali d'imballaggio utilizzati sono compatibili con l'ambiente e riciclabili. Il cartone è costituito dall'80% al 100% da carta riciclata.
Le parti in legno non sono state trattate chimicamente. I fogli sono in polietilene (PE), i nastri di fasciatura in polipropilene (PP) e le imbottiture, prive di CFC, sono in polistirolo espanso (PS). Questi materiali sono composti puri di idrocarburi e sono riciclabili.

La vostra vecchia asciugatrice

- ⚠ Rendere inutilizzabili gli apparecchi fuori uso.
Dopo aver sfilato la spina, o dopo che l'elettricista ha smontato il cavo d'allacciamento, tagliare e togliere il cavo di connessione. Distruggere o togliere la serratura dello sportello, per evitare che i bambini giocando rimangano imprigionati e possano rischiare la vita.
Il simbolo  sul prodotto o sull'imballo indica che tale prodotto non deve essere smaltito con i normali rifiuti domestici, bensì consegnato ad un punto di raccolta per il riciclaggio di apparecchi elettrici ed elettronici.
Contribuendo al corretto smaltimento di questo prodotto, lei proteggerà l'ambiente e la salute degli altri. Uno smaltimento scorretto mette in pericolo l'ambiente e la salute.
Il vostro vecchio apparecchio contiene materiali preziosi, che devono essere inviati ad un centro di recupero. Per ulteriori informazioni sul riciclaggio di questo prodotto si rivolga al suo comune, all'azienda addetta alla raccolta dei rifiuti o al negozio presso il quale ha acquistato il prodotto.



Dove si smaltiscono i vecchi apparecchi?

Ovunque si vendano apparecchi nuovi oppure consegnandoli ai centri di raccolta o ai riciclatori S.EN.S ufficiali.

La lista dei centri di raccolta S.EN.S ufficiali è reperibile all'indirizzo www.sens.ch

Consigli per la sicurezza ed avvertimenti

Questo apparecchio soddisfa le norme per la sicurezza relative agli apparecchi elettrici.

Cosa fare prima della messa in funzione:

- ⚠ Leggere attentamente le istruzioni allegate, prima di mettere in funzione la vostra asciugatrice. Ci sono

importanti informazioni relative all'installazione, all'uso ed alla sicurezza dell'apparecchio.

- ⚠ Le riparazioni devono essere eseguite esclusivamente da personale specializzato. Le riparazioni non idonee possono provocare gravi danni materiali e causare pericoli per l'utente.
- ⚠ Conservare con cura tutta la documentazione per altre persone che utilizzano l'asciugatrice o per eventuali proprietari futuri.
- ⚠ Installare l'apparecchio secondo le relative istruzioni.
- ⚠ Non collegare un apparecchio che presenti danni evidenti. In caso di dubbio, chiedere informazioni al Servizio Assistenza o al rivenditore.

Durante l'asciugatura fare attenzione a quanto segue:

- ⚠ Non lasciare i bambini in prossimità dell'apparecchio, senza controllarli.
- ⚠ Tenere gli animali domestici lontani dall'apparecchio.
- ⚠ L'apparecchio è concepito esclusivamente per l'asciugazione domestica di tessuti.

Fare attenzione a fine programma:

- ⚠ Non introdurre la mano nel cestello rotante.

Per la salvaguardia dell'asciugatrice:

- ⚠ Non salire sulla macchina.
- ⚠ Non sedersi, né sorreggersi, né appoggiarsi sul sportello. (Pericolo di ribaltamento!)

Durante il trasporto fare attenzione a quanto segue:

- ⚠ Attenzione durante il trasporto dell'asciugatrice: pericolo di ferirsi! Non sollevare l'apparecchio facendo presa sulle parti sporgenti!

Rispetto per l'ambiente e consigli per risparmiare

Per risparmiare corrente, tempo e costi

- ▶ Il sistema d'asciugazione più economico e meno nocivo per l'ambiente è quello di caricare la quantità massima di biancheria consentita.
- ▶ Non superare la quantità massima di biancheria indicata (vedere la tabella dei programmi a pagina 37/38).
- ▶ Centrifugare i capi in lavatrice o in una centrifuga prima di asciugarli, per eliminare completamente l'acqua. Maggiore è la velocità di centrifugazione, minori saranno i tempi di asciugatura e, di conseguenza, i consumi d'energia elettrica.
- ▶ Centrifugare anche i capi delicati.
- ▶ Durante il processo di asciugatura si deve provvedere ad una buona aerazione dell'ambiente (aprire la fine-

Descrizione dell'asciugatrice

Pannello di comando e visualizzazione

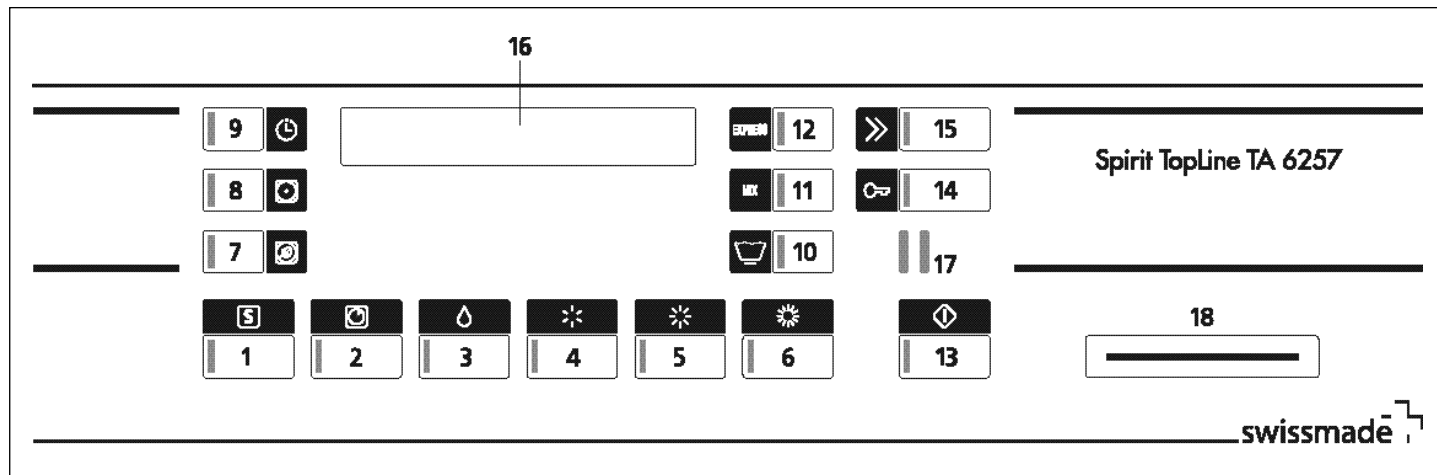

Programmi

- 1 Programmi speciali
- 2 Asciugatura a tempo
- 3 Umido per stiratura
- 4 Asciugatura leggera
- 5 Asciugatura normale
- 6 Asciugatura intensa
- 11 Biancheria mista
- 12 Programma espresso

Indicatori

- 16 Display digitale

Interfacce

- 17 SCS-Schulthess Control System (interfaccia PC per assistenza clienti)
- 18 Fessura per l'introduzione della cash-card (Option)

Funzioni supplementari

- 7 Asciugatura delicata extra
- 8 Asciugatura delicata
- 9 Impostazione timer
- 10 Capi di facile manutenzione
- 13 Avvio del programma
- 14 Apertura dello sportello di riempimento
- 15 Ciclo veloce

Pannello di comando ed indicatori



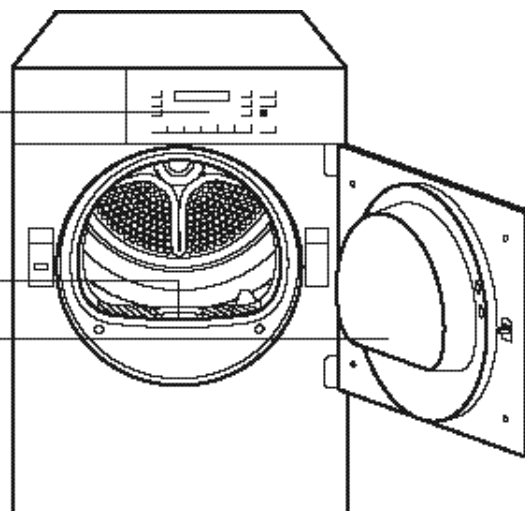

Filtro

Sportello di riempimento



Consigli per il bucato



Selezione dei capi

-  Controllare i simboli di asciugatura sulle etichette dei tessuti.
-  Asciugazione a temperatura normale.
-  Asciugazione a bassa temperatura.
-  Non asciugare con l'asciugatrice.
-  Non utilizzare l'asciugatrice per i seguenti tessuti:
 - Tessuti sensibili (seta, tende sintetiche ecc.): formazione di pieghe!
 - Biancheria troppo bagnata: spreco di energia!
 - Lana o tessuti in misto lana (tranne con il programma «Lana finish»): pericolo d'infeltrimento!

► Per ottenere un'asciugazione uniforme, suddividere la biancheria per tipo di tessuto e per grado d'asciugazione desiderato.

Non superare la quantità massima di carico consentita, poiché il sovraccarico pregiudica i risultati dell'asciugazione e sgualcisce molto la biancheria.

Consigli per l'asciugazione

- Chiudere le cerniere lampo, i ganci e gli occhielli. Per favore chiudere i bottoni degli copripiumini e federe. Allacciare le cinture aperte, legare insieme i nastri dei grembiuli, ecc.
- Se possibile, togliere i capi delicati dall'asciugatrice ancora leggermente umidi (selezionare il grado di asciugatura leggero). In caso d'eccessiva asciugatura c'è il rischio che si sgualciscano.
- I capi che risultassero ancora umidi al termine del ciclo d'asciugazione (carico misto cotonati) possono essere asciugati con un programma a tempo .
- I tessuti lavorati, ad. es. i capi in maglia, potrebbero restringersi con l'asciugazione. Per questo tipo di tessuti non utilizzare il programma «Asciugatura forte» .

Messa in funzione

-  Installare l'asciugatrice seguendo le relative istruzioni. Prima di mettere in funzione l'asciugatrice per la prima volta, pulire il cestello con un panno umido.





Preparazione

- Controllare che:
- Sia inserito il filtro per i pelucchi. (Vedi «Manutenzione / Cura / Pulizia» a pagina 41).
 - La spina sia inserita o l'interruttore a parete acceso.
- L'asciugatrice è pronta ad entrare in funzione, se tutte le spie di controllo lampeggiano oppure sono spente. Nel caso che una spia rimanga continuamente accesa, procedere come segue:
- Premere il tasto «Ciclo veloce», finché non si accende la spia di controllo «Fine del programma». Attendere che la spia di controllo lampeggi, quindi premere il tasto «Sportello» (eventualmente estrarre la biancheria).

Apertura dello sportello

-  ► Premere il tasto «Sportello».
- Il sportello si apre.
- Attenzione: Il sportello si apre solamente se è inserita l'alimentazione di corrente principale. Se dovesse essere mancata la corrente prima dell'apertura dello sportello (ad esempio per mancanza di moneta), allora può essere aperto manualmente premendo all'altezza del bloccaggio dello sportello.
- La luce del cestello si accende al momento dell'apertura dello sportello.

Inserimento della biancheria

-  Prima di inserire la biancheria accertarsi che nel cestello non si trovino corpi estranei, né animali domestici che eventualmente si sono nascosti.
-  Utilizzare l'asciugatrice solo per i capi che sono stati lavati ad acqua.
-  Non asciugare nell'apparecchio capi che in precedenza siano stati trattati con solventi infiammabili, per esempio con smacchiatori o benzina per smacchiare (pericolo di esplosione)!
-  Non utilizzare l'asciugatrice per tessuti che contengono gommapiuma o che sono impregnati di lacca, acetone per unghie o sostanze simili (pericolo di incendio)!
 - Inserire nel cestello i capi ben aperti, mischiando i capi grandi e piccoli.

Chiusura dello sportello

- Per chiudere lo sportello, premerlo finché non si sente scattare chiaramente la serratura.
- Accertarsi che nel chiudere lo sportello non vi rimangano impigliati dei capi.

Tabella dei programmi

 Beachten Sie stets die Pflegekennzeichen der Textilien





























Simbolo sull'etichetta	Quantità max. di biancheria	Tessuto/Tipo di biancheria	Grado d'asciugatura del programma	Tasti per la selezione del programma	Centrifugato in lavatrice alla velocità giri/min.	Consumo di corrente in kWh ca.	Durata in min. circa
Capi resistenti e colorati in cotone o lino							
	7 kg	<ul style="list-style-type: none"> Lenzuola, tovaglie, asciugamani, T-Shirts, magliette polo, vestiti da lavoro T-Shirts, magliette polo, abiti, pantaloni, vestiti da lavoro, biancheria intima, calzini in cotone Asciugamani di spugna e non, canovacci per piatti, lenzuola, biancheria intima, calzini in cotone Accappatoi e lenzuola in spugna 	<ul style="list-style-type: none"> Stiratura con ferro Asciugatura leggera Asciugatura normale 	<ul style="list-style-type: none">    	<ul style="list-style-type: none"> 1400/1000 1400/1000 1400/1000 	<ul style="list-style-type: none"> 2,4/2,4 3,0/3,5 3,3/3,9 	<ul style="list-style-type: none"> 30/35 36/41 41/47
45	Capi delicati (che non si stirano) in tessuto sintetico e misto, cotone da non stirare, ad es. viscosa, cupro, modal, poliestere						
	3,5 kg	<ul style="list-style-type: none"> Pantaloni, abiti, gonne, camicie Pantaloni, abiti, gonne, camicie, bluse, capi di corsetteria, fuseaux, capi di abbigliamento sportivo ad alto contenuto di fibre sintetiche Camicie da uomo, bluse, capi di abbigliamento sportivo, lenzuola, tovaglie, tute sportive Giacche a vento, coperto 	<ul style="list-style-type: none"> Stiratura con ferro Asciugatura leggera Asciugatura normale Asciugatura forte 	<ul style="list-style-type: none">  +  +  +  + 	<ul style="list-style-type: none"> 800/600 800/600 800/600 800/600 	<ul style="list-style-type: none"> 0,9/1,1 1,1/1,3 1,3/1,6 1,7 	<ul style="list-style-type: none"> 18/22 23/27 27/31 33
Programmi speciali							
	2,3 kg	<ul style="list-style-type: none"> Abbigliamento sportivo, capi in fibre sintetiche e tessuto misto 	Asciugatura normale		600	1,4	33
	3,5 kg	<ul style="list-style-type: none"> Misto Capi di abbigliamento misti 	Asciugatura forte		800/600	2,5/2,7	45/50
		<ul style="list-style-type: none"> Asciugatura a tempo Capi singoli, capi pocco umidi 	Asciugatura a tempo				
	<ul style="list-style-type: none"> Per i tessuti particolarmente sensibili alle temperature premere il tasto «Asciugatura delicata» o «Asciugatura delicata extra» 						
<p>I valori di consumo presentati sono indicativi e sono stati rilevati in condizioni di esercizio normali. Sono possibili scostamenti fino ad un limite del 10%. Negli apparecchi con potenza allacciata ridotta, i tempi dei programmi si prolungano.</p>							

Tabella dei programmi

 Beachten Sie stets die Pflegekennzeichen der Textilien

Simbolo sull'etichetta	Quantità max. di bianch.	Tessuto/Tipo di biancheria	Grado d'asciugatura del programma	Tasti per la selezione del programma	Centrifugato in lavatrice alla velocità giri/min.	Consumo di corrente in kWh ca.	Durata in min. circa
Programmi speciali «S»							
	3,5 kg	● Lana resistente al lavaggio meccanico	Lana Finish Asciugatura morbida (non completamente asciutta)	 1x	800	0,1	5
	3,5 kg	● Jeans	Jeans Umido per stiratura	 2x	400	1,7	28
	2,3 kg	● Bluse/Camicie	Bluse/Camicie Umido per stiratura	 3x	400	1,1	20
	2,3 kg	● Abbigliamento outdoor	Outdoor Asciugatura normale	 4x	600	1,8	62
	1 capo	● Cuscini grandi e piccoli	Cuscini Asciugatura a tempo	 5x 10-150 min.	600	5,6	150
	7 kg	● Capi in spugna	Capi in spugna Asciugatura normale	 6x	max. 1400	3,7	43
	7 kg	● Lenzuola	Lenzuola Asciugatura normale	 7x	max. 1400	3,7	48
	Per i tessuti particolarmente sensibili alle temperature premere il tasto «Asciugatura delicata»						
I valori di consumo presentati sono indicativi e sono stati rilevati in condizioni di esercizio normali. Sono possibili scostamenti fino ad un limite del 10%. Negli apparecchi con potenza allacciata ridotta, i tempi dei programmi si prolungano.							

⚠ Se lo sportello non è stato chiuso, un dispositivo di sicurezza impedisce la messa in funzione dell'apparecchio.

Asciugazione

Programmi d'asciugazione

Il sistema di rilevamento elettronico, dotato di sensori precisi, controlla costantemente il grado di umidità dei vostri capi e termina il programma automaticamente al momento in cui è stato raggiunto il grado d'asciugazione impostato.

Selezionare il programma per tessuti resistenti, colorati o delicati, seguendo la tabella dei programmi.



► Premere il tasto del programma.

● Si accende la spia luminosa del programma selezionato.

► Per i tessuti delicati selezionare la funzione supplementare «Capi delicati» .

Programma espresso: 2,3 kg



Programma speciale per l'asciugatura rapida di capi in tessuto sintetico, per es. abbigliamento sportivo in tessuto sintetico o misto. La biancheria esce asciutta normale.

► Premere il tasto di avvio del programma.

● La spia di controllo si illumina.

Programma misto: 3,5 kg



Per l'asciugatura intensa di capi misti in cotone e articoli tessili di facile manutenzione.

► Premere il tasto di avvio del programma.

● La spia di controllo si illumina.

Programmi a tempo



Per asciugare singoli capi di biancheria o per finire di asciugare tessuti già preasciugati con un basso contenuto di umidità. Il tempo d'asciugazione da impostare dipende dal tipo di biancheria, dalla quantità di biancheria e dal contenuto di umidità.

► Premere il tasto del programma.

● Si accende la spia luminosa «Programma a tempo» e viene indicato il tempo d'asciugatura minimo di 10

min.

► Selezionare il tempo d'asciugazione, fino ad un massimo di 150 min, premendo più volte il tasto.

Programmi speciali



Con i programmi speciali si possono asciugare in modo mirato alcuni tipi di tessuto. Premere ripetutamente il tasto **S** finché sul display appare il programma desiderato. (Vedi «tabella dei programmi» pagina 38)

Selezionare le funzioni supplementari



Dopo aver selezionato il programma, lampeggiano le spie luminose delle funzioni supplementari, che all'occorrenza possono essere inserite.

► Premere il tasto, oppure i tasti, delle funzioni desiderate. (Vedi «funzioni supplementari» a pagina 38).

● Si accende la spia luminosa della funzione selezionata, ovvero si accendono le spie luminose delle funzioni selezionate.

Avvio del programma



► Premere il tasto «Avvio».

● La spia luminosa si accende ed il programma parte automaticamente.



Nel caso sia inserito il dispositivo di sicurezza per i bambini:

► Tenere premuto il tasto «Ciclo veloce» ed azionare il tasto «Avvio».

Svolgimento del programma / Fase del programma

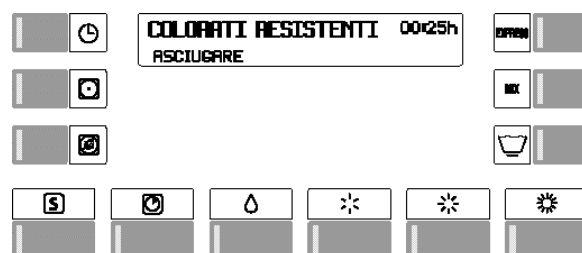

► Nei programmi in base all'umidità residua il sistema di rilevamento elettronico controlla costantemente il grado d'umidità della biancheria.

- Viene visualizzata la durata residua del programma. Questo tempo residuo viene ricalcolato più volte durante l'asciugatura, pertanto l'effettiva fine del programma varia di alcuni minuti.

- ▶ Nei programmi a tempo viene indicato il tempo che rimane prima della fine del programma.

Cambiare programma prima dell'avvio del programma

- ▶ Premere nuovamente il tasto del programma desiderato.
- Lampeggiano nuovamente tutte le spie di controllo delle funzioni supplementari che possono essere selezionate e tutte le impostazioni vengono cancellate.
- ▶ Ev. selezionare le funzioni supplementari.
- ▶ Avviare il programma.

Interruzione del programma



- ▶ Interrompere il programma premendo più volte il tasto «Ciclo veloce», finché sul display compare «Fine del programma».



- ▶ Tener premuto il tasto «Avvio».
- ▶ Contemporaneamente premere il tasto «Ciclo veloce».

Aggiunta di biancheria

effettuabile in ogni momento.



- ▶ Premere il tasto «Sportello».
- Il tamburo si ferma.
- ▶ Introdurre la biancheria.
- ▶ Chiudere lo sportello.
- ▶ Premere il tasto «Avvio».



- Se è inserito il dispositivo di sicurezza per i bambini:
 - ▶ Mantenere premuti entrambi i tasti «Avvio» e «Ciclo veloce».
 - ▶ Il processo di asciugatura riprende.

Fine programma

La fine del programma viene visualizzata dal valore 00:00h, il display indica «Fine programma» e la spia lampeggia.

- Viene emesso un segnale acustico (solamente nel caso in cui è inserita l'apposita funzione di segnalazione.)
- ▶ Nell'impostazione di base è inserita la funzione anti-piega. Dopo la fine del programma il tamburo continua a ruotare a brevi intervalli in modo che la biancheria non si sgualcisca (per 30 o 60 minuti). Dopodiché la biancheria dovrebbe essere rimossa.

Togliere la biancheria



- ▶ Premere il tasto «Sportello».
- Il tamburo viene illuminato.
- ▶ Togliere la biancheria.
- ▶ Pulire il filtro (pagina 41).
- ▶ Chiudere lo sportello

Spegnere l'asciugatrice

- ▶ Spegnere l'interruttore a parete.

Funzioni supplementari

Oltre ai diversi programmi d'asciugazione la vostra asciugatrice vi offre la possibilità di creare programmi personalizzati. Selezionando una o più funzioni supplementari potete impostare il vostro programma di asciugazione in base alle caratteristiche specifiche della vostra biancheria.

- ▶ Avete inoltre la possibilità di standardizzare la vostra asciugatrice alle vostre necessità personali, cambiando le impostazioni di base (vedi pagina 40).

Capi delicati



Per capi delicati in tessuto sintetico, tessuti misti o cotone da non stirare.

Impostazione timer



Premendo una o più volte il tasto «Impostazione timer» si può impostare l'ora d'avvio in modo che l'asciugabiancheria entri in funzione entro le 23,5 ore successive.

Questo consente, ad esempio, di sfruttare la tariffa ridotta per la corrente erogata durante la notte. L'inizio e la fine di un programma possono quindi essere adeguati alle proprie abitudini di vita.

Nel display viene visualizzato il tempo di avvio ed il tempo residuo per finire il programma.

L'ora preselezionata inizia a decorrere dopo l'attivazione del tasto di avvio.

Una volta raggiunta l'ora di avvio, il programma si attiva automaticamente e viene visualizzata la sua durata effettiva.

Modificare il tempo di preselezione

- Il tempo di preselezione può essere interrotto premendo il tasto di ciclo veloce. L'orario di avvio può essere nuovamente selezionato.

Avvertenza

- In caso d'interruzione di corrente rimane memorizzato il tempo attuale. Non viene tenuta in considerazione la durata dell'interruzione di corrente.

Asciugatura delicata



Il tasto «Asciugatura delicata» deve essere premuto nel caso di tessuti particolarmente sensibili alle temperature, quali ad esempio le fibre acriliche. La temperatura viene ridotta ed il tempo d'asciugazione viene leggermente prolungato.

Asciugatura delicata extra



In caso di tessuti particolarmente delicati si può premere il tasto «Asciugatura delicata extra», in modo da ridurre ulteriormente la temperatura.

Ciclo veloce



Il programma può essere ridotto o interrotto, premendo il tasto «Ciclo veloce» (Vedi «Cambiamento/Interruzione del programma»).

Manutenzione/Cura/Pulizia

Pulizia dell'apparecchio

- ⚠ Prima di pulire l'apparecchio o eseguire lavori di manutenzione, accertarsi che la corrente sia disinserita.
- ⚠ Non spruzzare mai acqua sull'apparecchio.
- ⚠ Non utilizzare solventi! Queste sostanze potrebbero danneggiare alcuni componenti dell'asciugatrice; sviluppano vapori tossici e possono provocare un'esplosione!

Pulire la parte esterna ed i comandi dell'asciugatrice semplicemente con acqua saponata o con un normale detergente in commercio che non contenga solventi o che non sia abrasivo.

Pulizia del filtro

Utilizzando i capi di biancheria, si vengono a creare dei filamenti, che durante l'asciugazione si staccano e vanno a depositarsi nel filtro che si trova sul lato interno dello sportello. Quindi il filtro deve essere pulito dopo ogni ciclo d'asciugazione.

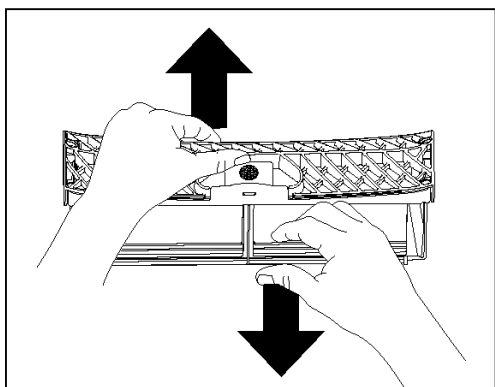
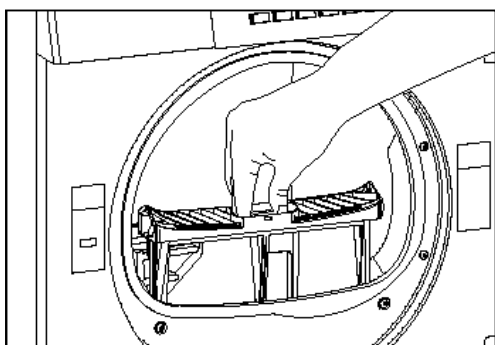

1. Premere il tasto «Aprire».
2. Estrarre il filtro e capovolgerlo.
3. Passare la mano sul filtro e rimuovere in questo modo i filamenti di tessuto. Può anche accadere che il filtro, anche se apparentemente sottoposto a regolare pulizia, diventi impermeabile a causa di un fine sedimento invisibile depositatosi nella mascherina del filtro. Tenere il filtro con una superficie rivolta verso l'alto e versarvi sopra dell'acqua. Se non lascia passare l'ac-

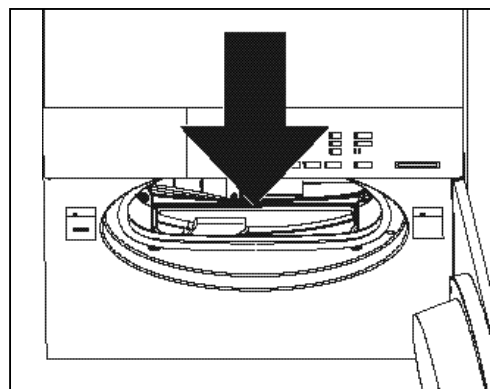

otto l'ac-

- 3.1 Ogni tanto è necessario rimuovere i filamenti che si sono depositati sul supporto. Per questa operazione utilizzare un'aspirapolvere o un pennello per spolverare.
- 3.2 Introdurre il tubo dell'aspirapolvere o il pennello per spolverare nell'apertura del filtro per i filamenti di tessuto e rimuovere interamente i filamenti residui.
4. Rimontare il filtro in modo corretto.
5. Chiudere lo sportello.

Pulizia dei rilevatori d'umidità

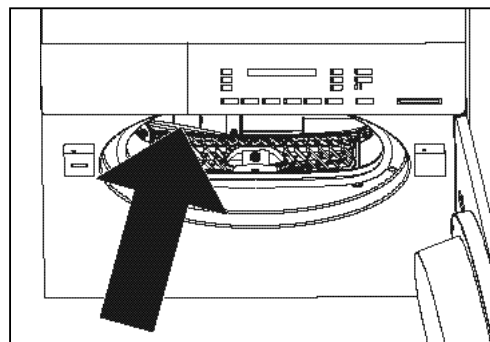

Dopo un uso prolungato si possono formare dei fini sedimenti di calcare o ammorbidente sulla parte frontale ed interna del tamburo, su entrambi i rilevatori d'umidità.

- ⚠ Nei programmi in base all'umidità residua questo può comportare il mancato raggiungimento del grado di asciugatura desiderato. Togliere i sedimenti con un panno imbevuto in aceto.

Impostazioni di base

Sebbene i parametri base dell'asciugatrice siano già stati predisposti in fabbrica, prima dell'avviamento o in qualsiasi momento successivo le funzioni di seguito elencate vi permettono di adattarli alle vostre esigenze personali.

Le impostazioni di base possono essere cambiate solamente se nessun programma di asciugatura è in esecuzione. Per cambiare un'impostazione di base si deve sempre mantenere premuto il tasto (o i tasti) di programma e poi attivare il tasto «Ciclo veloce». Le relative funzioni vengono visualizzate sul display. Tenendo premuto il tasto (o i tasti) di programma e premendo più volte il tasto «Ciclo veloce» , la visualizzazione cambia.

Esempio:

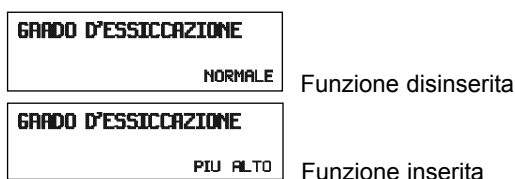

Grado d'asciugatura (valore preimpostato NORMALE)

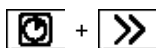

Se è inserita questa funzione, il grado d'asciugatura dei programmi elettronici (Asciugatura normale e forte) viene leggermente aumentato e la biancheria risulta un po' più asciutta.

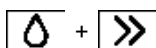

Protezione anti piega (valore preimpostato 30MIN)

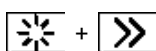

Attivando questa funzione, alla fine del programma inizia una fase di protezione anti piega della durata di 60 min.

Impostazione dell'ora (non preimpostata in fabbrica)



Il tasto  consente di regolare le ore e il tasto  di regolare i minuti.

Lingua (valore preimpostato: TEDESCO)





Questa impostazione vale temporaneamente per il programma selezionato e alcuni minuti dopo la fine del programma si passa nuovamente alla lingua di default.

(Vedi «Impostazioni estese/Lingua di default»)

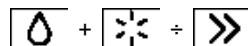
Altre impostazioni di base



- ▶ La pressione contemporanea su questi tre tasti attiva la visualizzazione delle impostazioni estese.
- ▶ La pressione ripetuta sul tasto  visualizza le impostazioni disponibili.
- ▶ La pressione sul tasto  permette di modificare le varie impostazioni.
- ▶ Con la pressione sul tasto  termina la visualizzazione delle impostazioni.

Dispositivo di sicurezza per bambini
(valore preimpostato: NO)



Selezionare «Impostazioni estese»!

Il dispositivo di sicurezza per i bambini serve ad evitare che i bambini facciano partire casualmente il programma, oppure lo cambino o lo cancellino.

Avvio di un programma quando è inserito il dispositivo di sicurezza per i bambini:

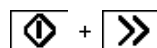

Tenere premuto il tasto «Avvio» e azionare il tasto «Ciclo veloce».

Memoria tasti (valore preimpostato: NO)



Selezionare «Impostazioni estese»!

Inserendo la funzione «Memoria tasti» viene salvato il programma speciale eseguito per ultimo, che compare per primo sul display la volta successiva in cui si preme il tasto . Premendo ripetutamente si possono selezionare in successione i programmi che seguono.

Un programma speciale utilizzato frequentemente può essere richiamato con una sola pressione su un tasto.

A funzione disinserita compare per primo il programma «Lana finish».

Tensione di allacciamento ridotta
(valore preimpostato: NO)



Selezionare «Impostazioni estese»!

La riduzione della tensione di allacciamento comporta un conseguente prolungamento dei tempi di programma.

No = 400 V 3N ~ 5,9 kW / 10 AT

Si = 400 V 2N ~ 4,4 kW / 10 AT

Luminosità del display (valore preimpostato: 150)



Selezionare «Impostazioni estese»!

Questo tasto  consente di modificare la luminosità o il tipo di carattere visualizzato.

Contrasto del display (valore preimpostato: 26)



Selezionare «Impostazioni estese»!

Questo tasto  consente di modificare il livello di contrasto del display.

Volume del cicalino (valore preimpostato: VOLUME 2)

 Selezionare «Impostazioni estese»!

Con cicalino attivato, al termine del programma viene emesso un segnale acustico ad intervalli regolari. Questo tasto consente di regolarne il volume su 3 livelli:

Inattivo
Volume 1
Volume 2
Volume 3

Funzione di standby (valore preimpostato: SI)

 Selezionare «Impostazioni estese»!

Se nessun programma è in esecuzione, l'attivazione di questa funzione commuta il funzionamento della macchina nello stato di risparmio energetico. Tutte le spie sono spente.



Interfaccia ottica (valore preimpostato: NO)

 Selezionare «Impostazioni estese»!

L'attivazione dell'interfaccia ottica (SCS) consente al Servizio Assistenza di comunicare con la macchina tramite PC.

Lingua di default (valore preimpostato: TEDESCO)

 Selezionare «Impostazioni estese»!

Se si seleziona temporaneamente un'altra lingua tramite i tasti  e , 4 minuti dopo la fine del programma, in modalità standby o dopo mancato funzionamento per un lungo periodo si passa nuovamente alla lingua di default.

Cash-Card

Introduzione della cash-card

Introdurre la cash-card con il simbolo  rivolto verso l'alto. Sul display, l'uno dopo l'altro, il «saldo nuovo» memorizzato sulla cash-card e l'acconto che viene detratto. L'eventuale importo rimanente nell'apparecchio viene conteggiato.

Se l'importo disponibile sulla cash-card non è sufficiente per il lavaggio, compare il messaggio «Saldo insufficiente» inoltre suona un segnale acustico. Si può quindi compensare la differenza con una seconda cash-card.

Ritiro della cash-card

Selezione ed avvio del programma di asciugare

- ▶ Selezione del programma di asciugare
- ▶ Selezione delle funzioni supplementari
- ▶ Avvio del programma

Visualizzazioni durante lo svolgimento del programma

COLORATI RESISTENTI	00:35h
CREDITO RESIDUO	2.60

Durante il programma di asciugare appaiono alternativamente le fasi del programma ed il credito residuo.

Fine del programma

Quando il programma di lavaggio è terminato, l'importo rimanente viene memorizzato nell'apparecchio a favore della relativa cash-card e conteggiato in occasione del processo di lavaggio. La fine del programma viene indicata dal tempo 00:00h e dall'indicazione «Apri sportello».

Recupero



Il recupero sulla cash-card dell'importo rimanente si fa di preferenza alla fine della giornata di bucato.

- ▶ Introdurre la carta. Sul display il «Saldo» memorizzato sulla cash-card.
- ▶ Avviare il recupero premendo il tasto «Ciclo veloce». Sul display, l'uno dopo l'altro, il «Credito residuo», che viene accreditato, ed il «saldo nuovo».
- ▶ Ritirare la cash-card.



Si può unicamente effettuare un recupero sulla cash-card dalla quale l'importo è stato originariamente detratto.



Nel caso sia inserito il dispositivo di sicurezza per bambini:

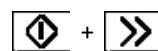

Utilizzo del resto sulla carta

Se l'importo sulla cash-card non basta per pagare la somma che inizialmente viene richiesta, l'apparecchio

emette un fischio e sull'indicatore lampeggia una spia. Sull'indicatore appare l'importo mancante. Introducendo una seconda cash-card si può pagare la differenza.

Anomalie

⚠ Riparazioni, modifiche o interventi su apparecchi elettrici devono essere eseguiti esclusivamente da personale specializzato. Le riparazioni non idonee possono provocare gravi danni materiali e causare pericoli per l'utente.

⚠ Per le riparazioni devono essere utilizzati solamente ricambi originali.

Come eliminare da soli piccole anomalie

La macchina non entra in funzione dopo aver premuto un tasto del programma:

- ▶ Controllare che l'interruttore a parete sia acceso e la spina sia inserita.
- ▶ Controllare che tutti i fusibili siano intatti oppure che sia scattato il salvavita.

L'apparecchio non entra in funzione:

- ▶ Non è stato premuto il tasto «Avvio».
- ▶ È impostata un'ora d'avvio. Parte solamente dopo che è trascorso il tempo d'avvio selezionato.

Il grado di asciugatura non è stato raggiunto.

- ▶ Pulire il filtro.
- ▶ Aumentare il grado di asciugatura (vedi pagina 42).
- ▶ Pulire i rilevatori d'umidità (vedi pagina 41).

Il tempo di asciugatura è troppo lungo.

- ▶ Pulire il filtro.
- ▶ Mancanza di corrente (Controllare i blocchi da parte della Società Elettrica)

La biancheria non si asciuga nonostante sia stato impostato il massimo grado di asciugatura.

- ▶ Il cestello è sovraccarico.
- ▶ La biancheria non è stata centrifugata a sufficienza.
- ▶ L'aerazione dell'ambiente non è sufficiente. (Aprire la porta o la finestra).
- ▶ Il filtro è otturato da filamenti di tessuto (pulire il filtro).

L'illuminazione del cestello non funziona.

- ▶ La lampadina è guasta. Per motivi di sicurezza la lampadina deve essere sostituita soltanto dal Servizio Assistenza o da un tecnico.

Consistente aumento d'umidità nell'ambiente.

- ▶ L'ambiente non è aerato sufficientemente. Provvedere ad una sufficiente aerazione dell'ambiente.

Il sportello è bloccato:

- ▶ Se dovesse essere mancata la corrente prima dell'apertura dello sportello (ad esempio per mancanza di moneta), allora può essere aperto manualmente premendo all'altezza del bloccaggio dello sportello

Segnalazioni di guasto

Nel caso vengano segnalate le seguenti anomalie, il programma può essere fatto ripartire, premendo il tasto «Avvio», dopo aver eliminato l'anomalia.

«DISPOSITIVO DI SICUREZZA PER I BAMBINI ATTIVATO»

- ▶ Mantenere premuto il tasto «Avvio» e azionare il tasto «Ciclo veloce».

«CHIUDERE SPORTELLO»

- ▶ Premere lo sportello finché la chiusura non si inserisce correttamente.

«CONTROLLA LIVELLO CALORE»

- ▶ Un segnale acustico viene emesso, il programma continua.

La segnalazione «controlla livello calore» appare e resta fino alla fine del programma. Premere una volta il tasto «Avvio» e poi premere diverse volte il tasto «Ciclo veloce» fino che viene visualizzato «fine programma».

- ▶ Controllare che tutti gli interruttori termici siano inseriti. Con un dito premere una sola volta su tutte le tre bussole di gomma rotonde (vedi figura). Se il problema persiste dopo aver premuto una volta, avvisare il servizio assistenza.

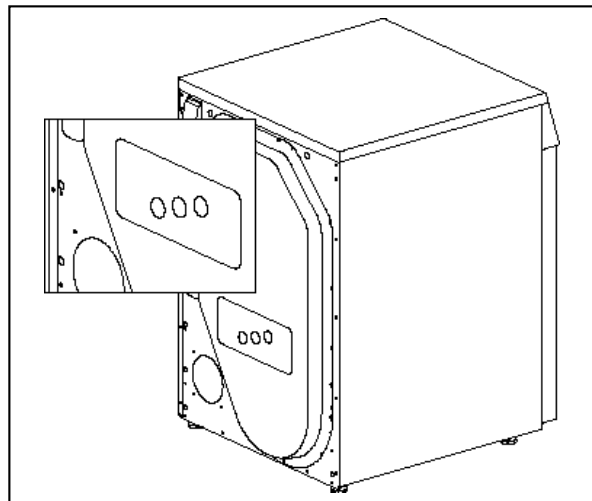

Se l'apparecchio segnala un messaggio di guasto F- - :

- ▶ Interrompere il programma con il tasto «Ciclo veloce» e selezionare un nuovo programma.

Se la segnalazione di guasto viene ripetuta:

- ▶ Interrompere per circa 1 minuto l'alimentazione di corrente e poi reinserirla. (Sfilare la spina o spegnere l'interruttore a parete).

Il l'apparecchio è nuovamente pronto ad entrare in funzione, se le spie luminose dei programmi lampeggiano.

- ▶ Selezionare un nuovo programma.

Se viene ancora indicata la segnalazione di guasto:

- ▶ Annotarsi il tipo di segnalazione di guasto.
- ▶ Sfilare la spina o spegnere l'interruttore a parete.
- ▶ Avvisare il Servizio Assistenza.

Segnalazioni di guasto (cash-card)

Le segnalazioni di guasto seguenti si riferiscono all'uso della cash-card.

Girare Carta

- ▶ Introdurre la cash-card con il simbolo  rivolto verso l'alto.

Carta vuota

- ▶ Utilizzare una cash-card carica.

Cash-card non valida

- ▶ La cash-card utilizzata non è valida. Informare l'addetto competente.

Reinserire Cash-Card

- ▶ Aspettare 5 secondi finché l'accredito è registrato e compare il nuovo saldo.

Servizio assistenza

Prima di rivolgervi al Servizio Assistenza, verificate se potete eliminare da soli l'anomalia. (Vedi «Eliminare da soli piccole anomalie» a pagina 44).

In caso di consulenza, anche durante il periodo di garanzia, vi saranno addebitati i costi per l'intervento di un tecnico.



Nel caso non siate in grado di eliminare da soli il guasto, sfilare la spina o spegnere l'interruttore a parete e rivolgersi al Servizio Assistenza.

Comporre il numero della sede centrale del Servizio Assistenza (vedi retro della busta). Sarete collegati automaticamente con la filiale del Servizio Assistenza competente per la vostra zona.

Vi preghiamo di indicare al Servizio Assistenza il numero di prodotto ed il numero dell'apparecchio. Troverete questi dati sulla targa di identificazione situata all'interno dello sportello. Segnare qui i numeri del vostro asciugabiancheria.

No. di prodotto _____

No. di apparecchio _____

Garanzia

Garanzia 1 anno.

Contents

What you need to know

- ▶ Waste disposal advice 48
 - ▷ Packaging from your new machine 48
 - ▷ Old machine 48
 - ▶ Safety advice and warnings 48
 - ▶ Environment and economy advice 48
-

Your new dryer

- ▶ Machine description 49
 - ▶ Laundry advice 50
 - ▷ Sorting laundry 50
 - ▷ Drying tips 50
-

Start up

- ▶ Preparation 50
 - ▶ Opening the door 50
 - ▶ Adding laundry 50
 - ▶ Closing the door 50
-

Drying

- ▶ Programme table 51/52
 - ▶ Drying 53
 - ▷ Drying programmes 53
 - ▷ Express programme 53
 - ▷ Mixed programme 53
 - ▷ Timer programme 53
 - ▷ Special programmes 53
 - ▷ Selecting additional functions 53
 - ▷ Starting the programme 53
 - ▷ Programme progress / 53
 - ▷ Programme status 53
 - ▷ Changing the programme 54
 - ▷ Interrupting the programme 54
 - ▷ Adding more washing 54
 - ▷ Programme end 54
 - ▷ Removing the laundry 54
 - ▷ Switching off the machine 54
 - ▶ Additional functions 54
 - ▷ Easy care 54
 - ▷ Start time preselect 54
 - ▷ Gentle drying 54
 - ▷ Gentle drying extra 54
 - ▷ Fast forward 54
-

Maintenance/Care/Cleaning

- ▶ Cleaning the machine 55
 - ▷ Cleaning the filter 55
 - ▷ Cleaning the moisture sensor 55
-

Basic settings

- ▶ Drying level 56
- ▶ Crease protection 56
- ▶ Time 56
- ▶ Language 56
- ▶ Extended basic settings 56

- ▷ Child lock 56
 - ▷ Button memory 56
 - ▷ Reduced mains power 56
 - ▷ LCD brightness / contrast 56
 - ▷ Alarm volume 57
 - ▷ Standby function 57
 - ▷ Optical interface 57
 - ▷ Default language 57
-

Cash Card

- ▶ Inserting the Cash Card 57
 - ▶ Removing the Cash Card 57
 - ▶ Selecting the drying programme 57
 - ▶ Displays during the programme sequence 57
 - ▶ Programme end 57
 - ▶ Re-crediting 57
 - ▶ Transferring remaining values 57
-

Problems

- ▶ Rectifying minor faults yourself 58
 - ▶ Error messages 58/59
-

Customer services

- ▶ Product and serial numbers 59
-

Guarantee

59

Inhaltsverzeichnis deutsch

- ▶ Siehe Seite 5
-

Sommaire français

- ▶ Voir page 19
-

Sommario italiano

- ▶ Vedere pagina 33
-

Waste Disposal Advice

Packaging from your new machine

- ⚠ Dispose of all packaging materials properly.
- ⚠ Packaging materials are not toys.
Processing and reuse saves raw materials and reduces waste volumes.
The packaging can be returned to the retailer or supplier.
All packaging materials used are environmentally friendly and reusable. All card is made of 80-100% recycled paper.
Wood is not chemically treated. Films are made of polyethylene (PE), banding is made of polypropylene (PP). These materials are pure hydrocarbon compounds and are recyclable.

Old Machines

- ⚠ Worn out machines should be made unusable:
After unplugging the machine or after an electrician has removed the connection, cut through and remove the mains cable. Destroy or remove the door lock so that playing children cannot become locked in and put their lives at risk.
The symbol  on the product or its packaging indicates that it is not to be disposed of as normal household waste, but must be taken to a collection point for the recycling of electrical and electronic appliances.
Through your contribution to the correct disposal of this product, you are helping to safeguard the environment and health of your fellow human beings. Improper disposal constitutes a hazard to the environment and health.
The old machine contains valuable materials which should be sent for recycling. Additional information on the recycling of this product can be obtained from your commune, your waste disposal contractor or the shop in which you bought the product.



Where to take old appliances?

Anywhere that new appliances are sold, or to the official S.EN.S collection points or official S.EN.S recyclers.

The list of S.EN.S collection points can be found at www.sens.ch

Safety Advice and Warnings

This machine meets the stringent safety regulations for electronic devices.

Before using the machine:

- ⚠ Read the enclosed documents carefully before using your dryer. They contain important information on the installation, use and safety of the machine.

- ⚠ Repairs should only be carried out by trained specialists. Incorrect repairs may cause considerable damage and risks to the user.
- ⚠ Keep the documents safe for other users or subsequent owners.
- ⚠ Install the machine according to the installation instructions.
- ⚠ Do not plug in a machine with visible damage. In case of doubt, ask customer services or your retailer.

When drying laundry:

- ⚠ Do not leave children unattended with the machine.
- ⚠ Keep pets away from the machine.
- ⚠ Only use the machine in the home for drying textiles.

At the end of the programme:

- ⚠ Do not reach into the rotating drum.

To protect your machine:

- ⚠ Do not climb on the machine.
- ⚠ Do not sit, lean or support yourself on the loading door (it could tip!).

When transporting your machine:

- ⚠ Take care when transporting the machine (risk of injury)!. Do not lift the machine by the fittings on the front!

Environment and Economy Advice

How to save electricity, time and costs

- ▶ Your dryer will be most environmentally friendly and economical if you fill the machine with the maximum laundry load.
- ▶ Do not exceed the maximum stated laundry load (see programme table, page 51/52).
- ▶ Remove as much water as possible from the laundry before drying by spinning in a washing machine or spin dryer. The higher the spin speed, the shorter the drying time and lower the energy consumption.
- ▶ You should also spin easy care laundry.
- ▶ Ensure good room ventilation when drying (open a window or door).
- ▶ Clean the filter after every drying cycle.

Machine description

Control and display area

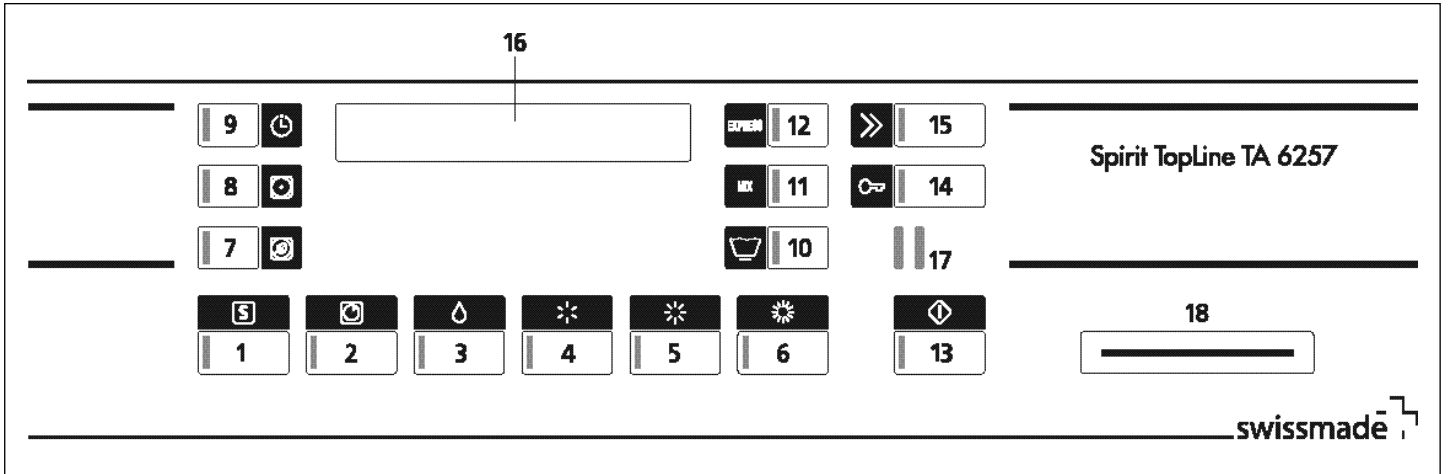

Programmes

- 1 Special programmes
- 2 Time drying
- 3 Iron dry
- 4 Light dry
- 5 Wardrobe dry
- 6 Extra dry
- 11 Mixed laundry
- 12 Express

Displays

- 16 Display

Interfaces

- 17 SCS-Schulthess Control System (PC interface for customer services)
- 18 Module opening for the cash card (Option)

Additional functions

- 7 Gentle dry extra
- 8 Gentle dry
- 9 Start time preselect
- 10 Easy care
- 13 Programme start
- 14 Open door
- 15 Fast forward

Control and display area

Filter

Door

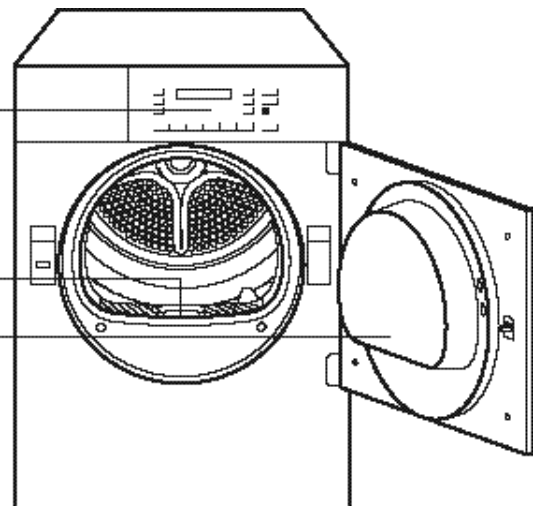



Laundry Advice

Sorting the laundry

-  Pay attention to the drying symbols on your fabrics.

 Dry at normal temperature.

 Dry at low temperature



 Do not tumble dry.

-  Do not dry the following fabrics in the machine:

- Sensitive fabrics (silk, synthetic curtains, etc.): creasing.
- Wringing wet laundry: waste of energy!
- Wool or textiles containing wool (Unless using the special programme «Wool Finish»): risk of felting!

▶ To achieve even drying results, sort the laundry by fabric type and desired level of dryness.
Do not exceed the maximum load, because overfilling affects the drying result and severely creases the laundry.

Tips for drying

- ▶ Do up all zips, hooks and eyes. Button up duvet covers and pillowcases. Tie together loose belts, apron strings etc.
- ▶ Remove easy care laundry from the dryer in a slightly damp state if possible (Select target dryness «Light Drying») and allow to finish drying in the air. Over drying causes creases.
- ▶ Laundry which is still too damp after drying a load of widely varying fabrics can be dried further using the timer programme .
- ▶ Knitted fabrics, e.g. jersey underwear, can shrink slightly during drying. Do not use the «Extra Dry»  programme for these fabrics.

Start-up

-  Install the machine according to the installation instructions.
Before using the machine for the first time, wipe the inside of the drum with a damp cloth.

Preparation

Check whether:

- ▶ The fluff filter is in place (see «Maintenance/Care/Cleaning», page 55).
- ▶ The machine is plugged in or switched on at the wall.

The machine is ready for use if all the control lights are flashing or have gone out in sleep mode. If one of the control lights stays on, proceed as follows:





- ▶ With the fast forward button in the programme end position, press until the control light comes on. Wait until the control light flashes and press the «Open» button. (remove laundry if necessary).

Open the door



- ▶ Press the «Open» button.
 - The door pops open
- ▶ Caution: The door only pops open if the mains power supply is switched on. If there is no power to open the door, the door can be opened manually by pressing next to the lock.
- The drum light comes on when the door is opened.

Add laundry





















-  Before adding laundry, ensure that there are no foreign bodies or even trapped pets in the drum.
-  Only dry fabrics which have been washed with water in the dryer.
-  Laundry which has been treated with flammable solvents e.g. stain remover or white spirits, should not be dried in the dryer (Risk of explosion!).
-  Fabrics which contain foam rubber or which have hair spray, nail polish remover or similar substances on them should not be dried in the machine (fire risk!).
 - ▶ Place the laundry loosely in the drum, mixing large and small items.

Close the door

- ▶ Close the door by pushing it until the lock audibly engages.
- ▶ Ensure when closing the door that no laundry gets shut in it.
-  If the door is not closed, the safety switch will prevent the machine from operating.















Programme table

 Beachten Sie stets die Pflegekennzeichen der Textilien

Care Symbol	Max. load	Textile/Wash Type	Programme drying target	Programme selection button	Spun in washing machine at rpm	Approx. power cons. kWh	Approx. duration Min.
Boil and coloured wash, cotton or linen							
	7 kg	<ul style="list-style-type: none"> ● Bed and table linen, towels, T-shirts, polo shirts, work wear ● T-shirts, polo shirts, dresses, trousers, work wear, underwear ● Flannels, tea towels and towels, bed linen, underwear, cotton socks ● Towelling bathrobs and bed linen ● no underwear or socks 	<ul style="list-style-type: none"> ▶ for laundry to be ironed ▶ for laundry which will not be ironed or only lightly ironed ▶ for laundry which will not be ironed ▶ for particularly thick or multilayered fabrics 	   	1400 1000 1400 1000 1400 1000 1400 1000	2,4 2,9 3,0 3,5 3,3 3,9 3,6 4,2	30 35 36 41 41 47 45 50
Easy care (non-iron) laundry made of synthetic and mixed fibres and cotton with non-iron trim, e.g. viscose, cupro, modal, polyester							
	3,5 kg	<ul style="list-style-type: none"> ● Trousers, dresses, skirts, shirts ● Trousers, dresses, skirts, shirts, blouses, corsetry, leggings, sportswear with large proportion of synthetic fibres ● Over shirts, blouses, sportswear, bed and table linen, tracksuits ● Anoraks, covers 	<ul style="list-style-type: none"> ▶ for laundry to be ironed ▶ for laundry which will not be ironed or only lightly ironed ▶ for laundry which will not be ironed ▶ for particularly thick or multilayered fabrics 	 +   +   +   + 	800 600 800 600 800 600 800 600	0,9 1,1 1,1 1,3 1,3 1,6 1,7 1,9	18 22 23 27 27 31 33 39
Special programmes							
	2,3 kg	● Sportswear synthetics and mixed fibres	▶ Sports and weather gear The laundry will be wardrobe dry.		600	1,4	33
	3,5 kg	● Mix Mixed laundry items	▶ Cotton and mixed fibres The laundry will be extra dry		800 600	2,5 2,7	45 50
		● Timer drying Individual items, items with low moisture content	▶ To finish drying damp laundry items				
		For temperature sensitive fabrics press the additional «Gentle Dry» or «Gentle Drying extra» button!		 + 			
<p>The power consumption values and programme durations given are guidelines determined under standard conditions. Fluctuations of up to 10% are possible. The programme will be correspondingly longer for machines with reduced mains power.</p>							

Programme table

 Beachten Sie stets die Pflegekennzeichen der Textilien

Care Symbol	Max. load	Textile/Wash Type	Programme drying target	Programme selection button	Spun in washing machine at rpm	Approx. power cons. kWh	Approx. duration Min.
Special programmes «S»							
	3,5 kg	● Machine-washable wool	▶ The laundry becomes fleecier but not dry. Remove laundry directly after programme end and lay it out on a terry cloth for drying.	 1x	800	0,1	5
	3,5 kg	● Jeans	▶ Jeans and cotton trousers are dried until «Iron Damp». Then hang up the laundry and let it air-dry.	 2x	400	1,7	28
	2,3 kg	● Shirts/blouses	▶ Shirts and blouses are dried until «Iron Damp». The programme reduces folding, treats the laundry with care and additionally facilitates ironing.	 3x	400	1,1	20
	2,3 kg	● Outdoor clothing	▶ To dry outdoor clothing, down jackets, etc.	 4x	600	1,8	62
	1 wash load	● Cushions large or small	▶ Cushions, down jackets, etc. are dried until «Extra Dry». Turn cushions after 120 minutes if necessary.	Time  g	600	5,6	150
	7 kg	● Terry towels	▶ Cotton terry towelling, bath towels, bathrobes etc.	 6x	max. 1400	3,7	43
	7 kg	● Bed linen	▶ Cotton sheets, stretch-fit sheets, duvet covers, pillowcases etc. Please button up duvet covers and pillowcases.	 7x	max. 1400	37	48
	For temperature sensitive fabrics press the additional «Gentle Dry» or «Gentle Drying extra» button!						
The power consumption values and programme durations given are guidelines determined under standard conditions. Fluctuations of up to 10% are possible. The programme will be correspondingly longer for machines with reduced mains power.							

Drying

Drying programmes

The electronic sampling system continually checks the current level of dryness of your laundry and automatically stops the programme when it reaches the specified level of dryness.

Select the programme for boil and coloured washing or easy care fabrics from the programme table.

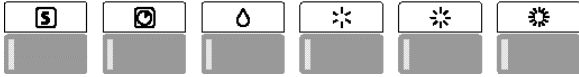

- ▶ Press the programme button.
- The control light for the selected programme lights up.
- ▶ For easy care fabrics, select the additional «Special programme» function .

Express programme: 2,3 kg



Special programme for drying synthetic fabrics quickly, e.g. sportswear made of synthetic or mixed fibres. The laundry will be wardrobe dry.

- ▶ Press the control button.
- The control light comes on.

Mixed programme: 3,5 kg

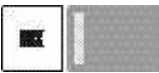

Mixed items made of cotton and easy care fabrics can be dried here. The laundry will be extra dry.

- ▶ Press the control button.
- The control light comes on.

Time programme



The time programme can be used for drying individual items or to finish drying fabrics with a low moisture content that have already been partially dried. The drying time required depends on the type and amount of laundry and how damp it is.

- ▶ Press the programme button.
- ! The time programme control light lights up and the minimum drying time of 10 minutes is displayed.
- ▶ Select the drying time by repeatedly pressing the button, up to a maximum of 150 minutes.

Special programmes



Using the special programmes, certain textiles can be dried especially adapted to the laundry. Tip the key  repeatedly until the desired programme appears on the display (see programme table, page 52).

Select additional functions

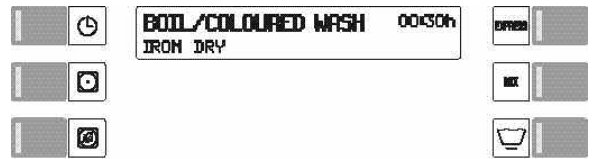

After the programme has been selected, the control lights flash for the additional functions which can be added if required.

- ▶ Press the desired function button(s) (see additional functions, page 52).
- The control light(s) for the selected additional function(s) light up.

Start programme

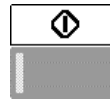

- ▶ Press the start button.
- The control light is illuminated and the programme starts automatically.



If the child lock is activated:

- ▶ Hold the start button down and press the fast forward button.

Programme progress / Programme status

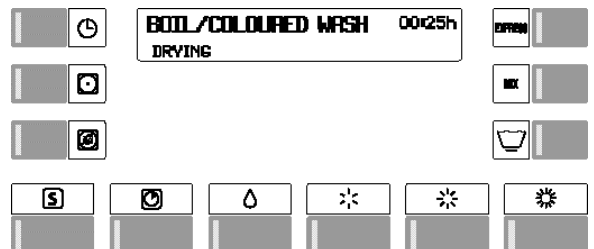

With the moisture controlled programmes the dampness of the laundry is continually monitored by an electronic sampling system.

- ▶ The programme time remaining is displayed. This remaining time is recalculated several times during drying, so the effective programme end will therefore vary by a few minutes.
- ▶ For time programmes, the time remaining to the end of the programme is displayed.

Changing a programme before the start

- ▶ Press the desired programme button again.
- All control lights for the available additional functions flash again and all settings are deleted.
- ▶ Select any additional functions.
- ▶ Start the programme.

Interrupting the programme

-  ▶ Interrupt the programme by pressing the fast forward button repeatedly, until «programme end» appears on the display.

-  If the child lock is activated:
- ▶ Hold the start button down.
 - ▶ Simultaneously tip the fast gear key.

Adding more laundry

This is possible at any time.

-  ▶ Press the door open button.
- Wait for the drum to stop.
 - ▶ Add your laundry.
 - ▶ Close the door again.
 - ▶ Press the start button.

-  If the child lock is activated:
- ▶ Hold down the start and fast forward buttons at the same time.
 - ▶ The drying process is continued.

Programme end

The programme end is indicated by the display value 00:00h, the display of «Programme End» as well as a flashing control light.

- An audible signal.
(only if summer function is switched on)
- ▶ In the default setting the creasing protection is enabled. After the end of the programme, the drum continues to rotate in short intervals, so that the laundry does not crease (30 or 60 minutes).

Remove the laundry

-  ▶ Press the door open button.
- The drum light comes on.
 - ▶ Remove the laundry.
 - ▶ Clean the filter (page 55).
 - ▶ Close the door.

Switch off the machine

- ▶ Switch the machine off at the wall.

Additional Functions

Alongside the various drying programmes, your dryer also offers you the opportunity to design your own programmes.

By selecting one or more additional functions, you can tailor your drying programme to the specifics of your laundry.

- ▶ You have the opportunity to tailor your dryer to your needs by changing the basic settings (see page 54).

Easy care



For easy care fabrics made of synthetic or mixed fibres, and cotton with a non-iron finish.

Start time preselect



By pressing the Start time preselect button one or more times, the programme start time can be delayed by up to 23,5 hours.

This makes it possible to take advantage of cheaper night-time electricity, for example. The start time and consequently also the end time of a programme can be tailored to your individual lifestyle.

The display shows the start time and anticipated programme time end.

The preselected time starts when the start button is pressed.

When the start time is reached, the selected programme starts automatically. The current programme duration will be displayed.

Changing the preset starting time

- In the event of a power cut, the current time is stored. The duration of the power cut is not taken into account. The start time can be newly selected.

Note

- The preset starting time can be cancelled by pressing the quick cycle button.

Gentle dry



The gentle drying button must be pressed for very temperature sensitive fabrics such as acrylic fibres. The temperature is reduced and the drying time is extended slightly.

Gentle dry extra



With especially sensible textiles, the key «Gentle Dry Extra» can be pushed. The temperature is further reduced.

Fast forward



The programme can be shortened or interrupted by pressing the fast forward button. (see changing / interrupting the programme).

Maintenance/Care/Cleaning

Cleaning the machine

- ⚠ Ensure that the power supply is switched off before any cleaning, care or maintenance work.
- ⚠ Under no circumstances spray the machine with water.
- ⚠ Do not use solvents! These substances can damage parts of the machine, produce poisonous vapour and carry the risk of explosion!

Casings and control areas should only be cleaned with soap or a commercially available, solvent-free, non-abrasive cleaning product.

Cleaning the filter

When fabrics are used, the fibres are rubbed (laundry fluff), which are released when the fabrics are dried, collecting in the filter on the inside of the door. The fluff filter must therefore be cleaned after every use.

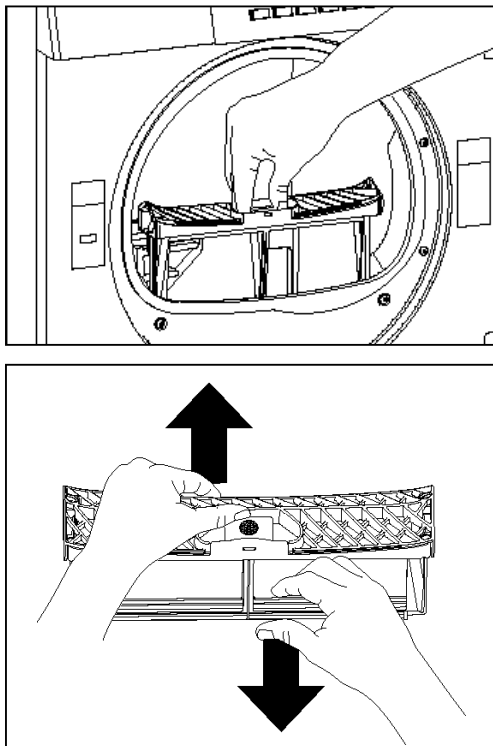

1. Press the door open button.
2. Pull out filter and open it.
3. Rub your hand over the filter and remove the fluff. It may happen that a supposedly proper cleaned filter becomes impermeable, due to a fine, invisible coat remaining in the filter meshes. Hold the filter with one flat surface upwards and pour a little water on to it. If it is impermeable, clean the filter with a brush under running water.

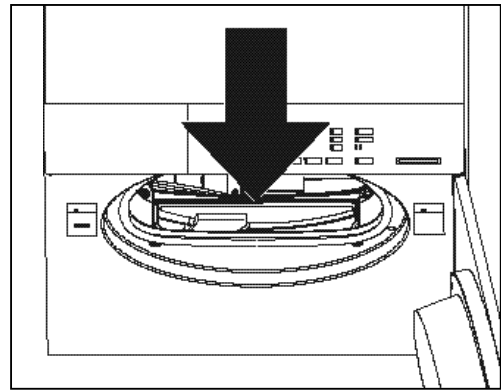

- 3.1 From time to time it is necessary to remove fluffs that have accumulated inside the filter support. To do so, use a vacuum cleaner or a cleaning brush.
- 3.2 Run the pipe of the vacuum cleaner or the brush around the opening for the fluff filter. Remove any residual fluff.
4. Replace the filter properly.
5. Close the door.

Cleaning the moisture sensor

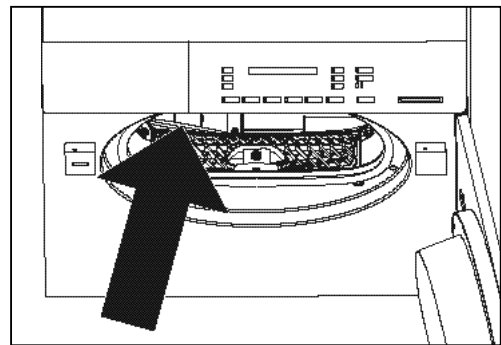

After longer operation, small deposits (lime, fabric refiner) can form on the front inner side of the drum on both sides of the longish moisture sensors.

- ⚠ With moisture controlled programmes, this can result in the desired level of dryness not being reached. Wipe deposits away with a cloth soaked in vinegar.

Basic Settings

The machine has basic settings from the factory. It can be adapted to the user's individual needs either when first used or later using the following functions.

The basic settings can only be changed if no dry programme is running. To change a basic setting, it is first necessary to hold the programme button(s) pressed and then press the fast forward button. The corresponding function is shown on the digital display. The display changes when the fast forward button  is pressed repeatedly with the programme button(s) held down.

Example:

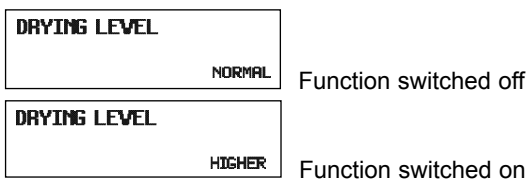

Drying level (ex factory NORMAL)

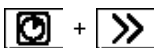

When this function is switched on, the level of dryness for the moisture controlled programmes (wardrobe and extra dry) is slightly increased and the laundry will be slightly drier.

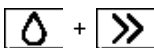

Crease protection (ex factory 30MIN)

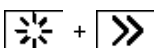

When this function is switched on, the crease protection phase begins at the end of the programme.

Time (the time is not set ex factory)



The hours can be set using the  button and the minutes using the  button.

Language (ex factory GERMAN)





This setting is temporarily valid for the selected programme and reverts back to the default language a few minutes after completion of the programme.

See «Advanced basic settings/default language»

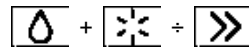
Extended basic settings



- ▶ By pressing these three buttons at the same time, the display shows the extended basic settings.
- ▶ Repeatedly pressing the  button shows the possible settings.
- ▶ Pressing the  button allows the settings to be changed.
- ▶ Pressing the  button ends the display of the settings.

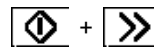

Child lock (ex factory OFF)

-  Select «Extended basic settings»!
- The child lock is to prevent accidental starting, changing or deletion of a programme by small children.
- Start a programme with the child lock switched on:



Hold the start button down and press the fast forward button.



Button memory (ex factory OFF)

-  Select «Extended basic settings»!
- With switched on memory button function, the special programme last used is stored and appears again as first on the display when next pressing the  button. Following this, the consecutive programmes can then be selected through repeatedly pressing the button.
- This way, a frequently used special programme can be called up with only one press of the button.
- With switched off function the «Wool Finish» programme appears as first.



Reduced mains power (ex factory OFF)

-  Select «Extended basic settings»!
- If the mains voltage is reduced, the programme times will be extended accordingly.
- Off = 400 V 3N ~ 5,9 kW / 10 AT
- On = 400 V 2N ~ 4,4 kW / 10 AT

LCD Brightness (ex factory 150)

-  Select «Extended basic settings»!
- The  button can be used to alter the brightness or text on the display.

LCD Contrast (ex factory 26)

-  Select «Extended basic settings»!
- The  button can be used to alter the contrast on the display.

Alarm volume (ex factory VOLUME 2)

 Select «Extended basic settings»!

With the Alarm setting switched on, a signal sounds at regular intervals at the end of the programme. The volume can be adjusted in 3 levels.

Off
Volume 1
Volume 2
Volume 3

Standby function (ex factory ON)

 Select «Extended basic settings»!

When the standby function is switched on, the controls switch off when no drying programme is running in energy saving mode. All displays are dark.



Optical interface (ex factory OFF)

 Select «Extended basic settings»!

If the optical interface (SCS) is switched on, customer services can communicate with the machine by PC.

Default language (ex factory German)

 Select «Extended basic settings»!

If another language is temporarily selected via the keys  and , 4 minutes after programme end, in standby mode or after a long standstill, the setting reverts back to the default language.

Cash Card

Inserting the Cash Card

Insert the Cash Card with the  symbol facing upwards. In the display will appear in succession the amount stored on the Cash Card, the amount on account which will be deducted, as well as the new Cash Card balance. Any remaining credit balance stored in the appliance will be set off.

If the amount available on the Cash Card is not sufficient for the wash, a signal will sound and the remaining amount will appear flashing in the display. The difference can be settled with a second Cash Card.

Removing the Cash Card

Selecting and starting the drying programme

- ▶ Select the drying programme
- ▶ Select the additional functions
- ▶ Start the programme

Displays during the programme sequence

BOIL/COLOURED WASH	00:35h
CREDIT	2.60

During the drying programme, the remaining time and the remaining credit balance are displayed alternately.

Programme end

When the drying programme is completed, the remaining amount is stored in the appliance under the appropriate Cash Card. This remaining credit balance will be set off

at the next washing cycle. The programme end is displayed by the display value 00:00h as well as the flashing control lamp «Open door».

Re-crediting



Re-crediting of the remaining credit balance is best made at the end of a washing day.

▶ Insert the Cash Card. The amount stored on the Cash Card will appear in the digital display.

▶ Re-credit by pressing the fast run button. In the digital display will appear in sequence the display the remaining credit balance which will be credited, as well as the new Cash Card balance.

▶ Remove the Cash Card.



Re-crediting can always be made only to that Cash Card from which the amount was originally deducted.



In the case of active child safety device:

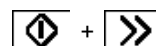

Remaining value transfer

If there is not an adequately high remaining amount available on a Cash Card to pay for the booking on account, this will be displayed by the whistle signal and by the flashing display with the message saldo to small. By inserting a second Cash Card, the difference can be paid.

Problems

- ⚠ Repairs, alterations or intervention on electronic equipment should only be carried out by qualified specialists. Inexpert repairs can cause considerable damage and risk to the user.
- ⚠ Only original spare parts should be used for repairs.

Rectifying minor faults yourself

The machine does not start after pressing a programme button:

- ▶ Check whether the mains power is switched on at the wall and the plug is in.
- ▶ Check whether all the fuses are intact or the safety switch has tripped.

The machine does not start:

- ▶ The start button has not been pressed.
- ▶ Start time preselect has been set. Only starts at the preselected start time.

The drying target was not achieved:

- ▶ Clean filter
- ▶ Increase degree of drying (see page 56).
- ▶ Clean moisture sensor (see page 55).

The drying takes too long:

- ▶ Clean filter.
- ▶ Power failure (note lock times of EW).

The laundry is not dry after the maximum possible settings:

- ▶ Drum is overloaded.
- ▶ Laundry not sufficiently spun.
- ▶ Insufficient room ventilation (open a window or door).
- ▶ The filter is blocked with fluff (clean filter).

Drum lighting does not work:

- ▶ Faulty light bulb. For safety reasons, the lamp should only be replaced by customer services or a specialist.

Dampness in the room increases significantly:

- ▶ The room does not have sufficient ventilation. Ensure adequate ventilation.

Door does not open:

- ▶ If no power is available to open the door, you can open the door manually by pressing next to the door lock.

Error messages

If the following error messages are displayed, the programme can be restarted by pressing the start button once the error has been rectified.

«CHILD LOCK»

- ▶ Hold the start button down and press the fast forward button.

«PLEASE CLOSE DOOR»

- ▶ Push door closed until lock engages.

«CHECK HEATING LEVEL»

- ▶ A signal tone will arise and the programme will continue running.

The error message «Check heating level» will occur in the display and will be displayed until the end of the programme. Please press the start button once and then the «Fast forward» button several times until the message «Programme end» is displayed.

- ▶ Check whether all the temperature switches are switched on. Push with your finger once around all 3 round rubber seals (see diagram). If the problem is not fixed after doing this once, inform customer services.

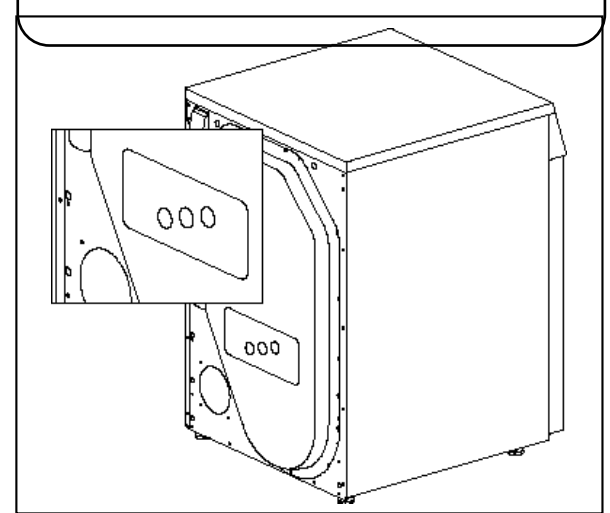

If the machine displays an F - - error message:

- ▶ Interrupt the programme using the fast forward button and select a new programme.

If error messages appear repeatedly:

- ▶ Switch off the power for around 1 minute and switch it back on again. (Pull out the plug or switch off at the wall).
- The machine is ready for use again when the programme control lights flash.
- ▶ Select a new programme.

If an error message appears again:

- ▶ Make a note of the error message.
- ▶ Unplug the machine or switch it off at the wall.
- ▶ Notify customer services.

Kundendienst

Zentrale Kundendienst-Nummern für die Schweiz

Tel. 0844 888 222

Fax 0844 888 223

Service après-vente

Numéros centralisés du service après-vente pour la Suisse

Tél. 0844 888 222

Fax 0844 888 223

Servizio assistenza

Numeri della sede centrale del Servizio Assistenza per la Svizzera

Tel. 0844 888 222

Fax 0844 888 223



Schulthess Maschinen AG/SA
Postfach/Case postale/Casella postale
CH-8633 Wolfhausen
Tel. 055 · 253 51 11
Fax 055 · 253 54 70
<http://www.schulthess.ch>

Schulthess Maschinen GmbH
Hetzendorferstrasse 191
A-1130 Wien
Tel. 01 · 803 98 00-20
Fax 01 · 803 98 00-30